

## Operating and Installation Instructions Microwave Oven



It is **essential** to read the operating and installation instructions before setup, installation, and commissioning. This prevents both personal injury and damage to the appliance.

## **PRECAUTIONS TO AVOID POSSIBLE EXPOSURE TO EXCESSIVE MICROWAVE ENERGY**

---

### **PRECAUTIONS TO AVOID POSSIBLE EXPOSURE TO EXCESSIVE MICROWAVE ENERGY**

- (a) Do not attempt to operate this oven with the door open since open-door operation can result in harmful exposure to microwave energy. It is important not to defeat or tamper with the safety interlocks.
- (b) Do not place any object between the oven front face and the door or allow soil or cleaner residue to accumulate on sealing surfaces.
- (c) Do not operate the oven if it is damaged. It is particularly important that the oven door close properly and that there is no damage to the: (1) Door (bent), (2) hinges and latches (broken or loosened), (3) door seals and sealing surfaces.
- (d) The oven should not be adjusted or repaired by anyone except properly qualified service personnel.

---

<b>PRECAUTIONS TO AVOID POSSIBLE EXPOSURE TO EXCESSIVE MICROWAVE ENERGY</b> .....	2
<b>IMPORTANT SAFETY INSTRUCTIONS</b> .....	5
<b>Before using for the first time</b> .....	16
<b>Installation</b> .....	17
Installation dimensions .....	17
Installation in a tall or base cabinet .....	17
Side view .....	18
Connections and ventilation .....	19
Installing the microwave oven .....	20
Electrical connection .....	22
<b>Caring for the environment</b> .....	24
<b>Overview</b> .....	25
<b>Control panel</b> .....	26
Display .....	27
Symbols .....	27
Sensor buttons .....	28
<b>Microwave operation</b> .....	30
How it works .....	30
Suitable dishware .....	30
Suitable dishware .....	31
Unsuitable dishware .....	32
Testing dishware .....	33
Cover .....	33
<b>Before first use</b> .....	34
Setting the time of day .....	34
<b>Settings</b> .....	35
Settings overview .....	35
Changing settings .....	37

# Contents

---

<b>Operation</b> .....	38
Tips for cooking with the microwave .....	38
Using the turntable.....	38
Starting a cooking process .....	38
Changing the microwave power level .....	39
Changing the cooking duration .....	39
Interrupting and resuming a cooking process.....	40
Canceling a cooking process .....	40
Automatic keeping warm function – <i>H:H</i> .....	40
Oven compartment query – <i>door</i> .....	40
Reheat drinks  .....	41
Switching the system lock on and off .....	41
<b>Timer</b> .....	42
<b>Quick MW and Popcorn</b> .....	43
<b>Automatic Programs</b> .....	45
Using automatic programs .....	45
Overview of automatic programs .....	46
Using automatic program <i>H 9</i> for vegetables .....	47
Recipes.....	47
Potatoes in a curry sauce.....	47
Salmon in white wine sauce.....	48
Carrots in a chervil cream sauce.....	48
<b>Additional applications</b> .....	49
Defrost .....	49
Reheat .....	50
Cooking .....	53
Canning .....	54
<b>Cleaning and care</b> .....	56
Unsuitable cleaning agents .....	56
Removing soiling .....	57
<b>Frequently asked questions</b> .....	59
<b>Customer Service</b> .....	62
Contact in the event of a fault.....	62
Appliance warranty and product registration .....	62

# IMPORTANT SAFETY INSTRUCTIONS

When using the appliance, follow basic safety precautions, including the following:

Read all instructions before installation and use of the oven to prevent accidents and machine damage.

**WARNING** - To reduce the risk of burns, electric shock, fire, injury to persons, or exposure to excessive microwave energy:

This appliance complies with current safety requirements. Improper use of the appliance can lead to personal injury and material damage.

Read all instructions before installing or using the oven for the first time. Only use the appliance for its intended purpose.

Keep these operating instructions in a safe place and pass them on to any future user.

Read and follow the specific “PRECAUTIONS TO AVOID POSSIBLE EXPOSURE TO EXCESSIVE MICROWAVE ENERGY” found at the beginning of this manual.

Only use the appliance for its intended purpose. Install or locate this appliance only in accordance with the provided installation instructions and all local codes.

## Appropriate use

- ▶ This microwave oven is intended for domestic use and use in other similar environments.
  - ▶ This microwave oven must not be used at altitudes exceeding 6562 ft. (2000 m).
  - ▶ The microwave oven is not intended for outdoor use.
  - ▶ The microwave oven is intended to cook, defrost, reheat and can food in domestic settings only.
- All other types of use are not permitted.

# IMPORTANT SAFETY INSTRUCTIONS

---

- ▶ Risk of fire due to flammable materials.

If flammable items are dried in the microwave oven, the moisture in the items will evaporate. This could cause the materials to dry out and possibly self-ignite.

Never use the microwave oven to store or dry items which could ignite easily.

- ▶ This microwave oven can only be used by people with reduced physical, sensory, or mental capabilities or lack of experience and knowledge if they are supervised while using it.

They may only use it unsupervised if they have been shown how to do so in a safe manner. They must be able to understand and recognize the possible dangers caused by incorrect operation.

- ▶ The oven compartment is equipped with special bulbs to cope with particular conditions (e.g., temperature, moisture, chemical resistance, abrasion resistance, and vibration). These special bulbs must only be used for the purpose for which they are intended. They are not suitable for room lighting. Replacement bulbs should only be installed by a Miele authorized technician or by Miele Customer Service.

## Safety with children

- ▶ Activate the system lock to ensure that children cannot switch on the microwave oven inadvertently.

- ▶ Children should be supervised in the vicinity of the microwave oven. Never allow children to play with the microwave oven.

- ▶ Burn Hazard - Do not allow children to use the microwave oven.

- ▶ Risk of suffocation from packaging material. While playing, children may become entangled in packaging material (such as plastic wrapping) or pull it over their head, presenting the risk of suffocation. Keep packaging material away from children.

- ▶ Risk of injury caused by hot surfaces. Children's skin is far more sensitive to high temperatures than that of adults. External parts of the microwave oven such as the control panel and the vent become quite hot.

Do not let children touch the microwave oven when it is in operation.

# IMPORTANT SAFETY INSTRUCTIONS

---

## Technical safety

- ▶ This appliance must be installed and connected in compliance with the installation instructions.
- ▶ Unauthorized installation, maintenance, and repairs can cause considerable danger for the user. Installation, maintenance, and repairs should only be carried out by a Miele authorized technician.
- ▶ Maintenance by the user: Never repair or replace any part of the appliance unless the instructions specifically recommend doing so. Service work should only be performed by a qualified technician.
- ▶ Damage to the microwave oven can compromise your safety. Check the microwave oven for visible signs of damage. Do not use a damaged microwave oven.
- ▶ Temporary or permanent operation on an autonomous power supply system or a power supply system that is not synchronized with the grid power supply (e.g., island networks, back-up systems) is possible. A prerequisite for operation is that the power supply system complies with national and local codes.  
The function and operation of the protective measures provided in the domestic electrical installation and in this Miele product must also be maintained in isolated operation or in operation that is not synchronized with the grid power supply, or these measures must be replaced by equivalent measures in the installation.
- ▶ Operating a damaged microwave oven can result in microwave leakage and present a hazard to the user. Do not use the microwave oven if:
  - The door is warped.
  - The door hinges are loose.
  - Holes or cracks are visible in the casing, the door, or the oven compartment walls.

## IMPORTANT SAFETY INSTRUCTIONS

---

- ▶ The electrical safety of this appliance can only be guaranteed when correctly grounded. It is essential that this basic safety requirement is fulfilled. If in doubt, the electrical installation should be checked by a qualified electrician.
- ▶ Proper installation: Make sure that your appliance has been installed correctly and that it has been grounded by a qualified technician.
- ▶ The connection data (voltage and frequency) on the data plate of the microwave oven must match the domestic electrical supply in order to avoid the risk of damage to the microwave oven. Compare this before connecting the appliance to the domestic electrical supply. If in any doubt, consult a qualified electrician.
- ▶ Power bars and extension cords do not guarantee the required safety of the appliance. Do not use these to connect the microwave oven to the power supply.
- ▶ For safety reasons, only use the microwave oven when it has been fully installed.
- ▶ This appliance must not be used in a non-stationary location (e.g., on a ship).
- ▶ Risk of injury due to electric shock. Any contact with live connections or tampering with the electrical or mechanical components of the microwave oven will endanger your safety and may lead to appliance malfunctions.  
Do not open the microwave oven housing under any circumstances.
- ▶ While the appliance is under warranty, repairs should only be undertaken by a service technician authorized by Miele Customer Service. Otherwise the warranty will be invalidated.
- ▶ Miele can only guarantee the safety of the appliance when original Miele parts are used. Faulty components must only be replaced with genuine Miele parts.



## IMPORTANT SAFETY INSTRUCTIONS

---

- ▶ If the power cord is damaged, it must be replaced with a special power cord by a Miele authorized technician (see “Installation – Electrical connection”).
- ▶ During installation, maintenance, and repair work, the microwave oven must be completely disconnected from the power supply. To ensure this:
  - The circuit breakers have been switched off, or
  - the fuses of the electrical installation have been completely removed, or
  - the plug (if present) is removed from the outlet. To do this, pull the plug not the cord.
- ▶ The microwave oven requires a sufficient supply of cool air for efficient operation. Make sure that the supply of cool air is not hindered in any way (e.g., by installing heat insulation strips in the cabinet niche). In addition, the required supply of cool air must not be excessively heated by other heat sources.
- ▶ If the microwave oven is built in behind a cabinet door front, do not close the cabinet door while the microwave oven is in use. Heat and moisture can build up behind the cabinet door when closed. This can result in damage to the microwave oven, cabinet niche, and floor. Leave the cabinet door front open until the microwave oven has cooled down completely.

### **Correct use**

- ▶ Do not let food sit in the oven for an extended period of time before or after cooking. Doing so can result in food poisoning or sickness.
- ▶ Smother the fire or flames, or use a dry chemical extinguishing agent or foam fire extinguisher.
- ▶ Never store flammable liquids and materials in, above or under the microwave oven.

## IMPORTANT SAFETY INSTRUCTIONS

---

- ▶ Do not obstruct the flow of combustion and ventilation air.
- ▶ This microwave oven must only be used for cooking food. Corrosive chemicals and vapors as well as fumes, vapors or heat given off by glues, plastics or flammable liquids and materials could be hazardous. Do not use it as a dryer, kiln, dehumidifier, etc.
- ▶ To avoid fueling any flames, do not open the microwave oven door if smoke occurs inside the appliance. Interrupt the process by turning the appliance off and disconnecting it from the power. Do not open the door until the smoke has dissipated.
- ▶ Due to the high temperatures radiated, objects left near the microwave oven could catch fire. Do not use the microwave oven to heat up the room.
- ▶ Oils and fats are a fire hazard if allowed to overheat. Never leave the microwave oven unattended when cooking with oil or fats. Never attempt to put out oil or fat fires with water. Turn the microwave oven off and extinguish the flames by leaving the door closed.
- ▶ Fire hazard. If using alcohol in your recipes, please be aware that high temperatures can cause the alcohol to evaporate. The vapor can catch fire on hot surfaces.  
Do not heat undiluted alcohol in the appliance.
- ▶ Food which is stored in the oven interior or left there to be kept warm can dry out, and the moisture released can lead to corrosion damage in the microwave oven. The control panel, countertop and surrounding cabinetry can also be damaged.  
Always cover food that is left in the appliance.
- ▶ The microwave oven is not suitable for cleaning or disinfecting items. Items can get extremely hot. There is a risk of burning when items are removed from the microwave oven.

## IMPORTANT SAFETY INSTRUCTIONS

---

- ▶ Always ensure that food is sufficiently heated.

Many factors will affect the overall cooking time, including the type, amount and nature of the food, its initial temperature, and changes to the recipe. Some foods may contain microorganisms which are only destroyed by thorough cooking. Therefore, when cooking or reheating food, it is particularly important that food is heated at adequate temperatures for a sufficient amount of time. When in doubt, select a longer cooking or reheating time.

- ▶ It is important that the temperature in the food being cooked is evenly distributed and sufficiently high.

You can ensure this by stirring or turning the food, and observing a sufficiently long standing time (see charts), which should be added to the time needed for reheating, defrosting, or cooking. During the standing time, the temperature is distributed evenly in the food.

- ▶ Always remember that times for cooking, reheating and defrosting in a microwave oven are usually considerably shorter than in the case of traditional methods of food preparation. Excessively long cooking times can lead to food drying out and burning, or may even cause it to catch fire.

Do not dry bread, rolls, flowers, herbs, etc., in the microwave oven as these could also catch fire.

- ▶ When heating food, and in particular liquids, using microwave power, the boiling point may be reached without the typical bubbles being produced. The liquid does not boil evenly throughout. This boiling delay can result in the liquid boiling over explosively. Take care when taking the container out of the microwave oven, as the hot liquid can cause severe scalding. Under certain circumstances, the pressure can be so high that the door opens automatically. Stir liquids well before heating or cooking. After heating, wait at least 20 seconds before removing the container from the microwave oven. In addition, you can place a glass rod or similar item, if available, in the container during the heating process.

## IMPORTANT SAFETY INSTRUCTIONS

---

▶ Risk of injury caused by hot food. When you heat food up, the heat is created directly in the food itself. For this reason, the dishware will remain cooler than the food (except when you use ovenproof stoneware). The dishware is only warmed by the heat of the food.

Before serving, always check the temperature of the actual food itself after taking it out of the oven. The temperature of the container is not an indication of the temperature of the food or liquid in it. **This is particularly important when preparing food for babies, children, and the elderly or infirm.** After heating food, especially food for babies and small children, stir the food or shake the container and check that the temperature does not pose any danger of burning. Double check after it has been left to stand.

▶ Risk of injury from increased pressure in sealed containers or bottles. Pressure can build up when reheating food or drinks in sealed containers or bottles, which can cause them to explode. Never cook or reheat food or liquids in sealed containers or bottles. Open containers beforehand and with baby bottles, the screw top and nipple must be removed.

▶ If you cook eggs without their shells, the yolks could explode due to the resulting pressure. Prick the yolk several times before cooking to avoid this.

▶ Eggs heated in their shell can burst, even after they have been removed from the microwave oven. Eggs can only be cooked in their shells in a specially designed egg-boiling device. Do not reheat hard-boiled eggs in the microwave oven.

▶ Food with a thick skin or peel, such as tomatoes, sausage, potatoes, and eggplant can burst when heated or cooked. Pierce or score the skin of these foods several times to allow steam to escape.

## IMPORTANT SAFETY INSTRUCTIONS

---

▶ Do not use a thermometer containing mercury or liquid as these are not suitable for use with very high temperatures and break very easily.

To check food temperature, first interrupt the cooking process. Only use a thermometer specifically approved for food use to measure the temperature of the food.

▶ Cushions or pads filled with cherry kernels, gel, etc., such as those used in aromatherapy, can ignite when heated, even after they have been removed from the microwave oven.

Do not heat these up in the microwave oven.

▶ Moisture can collect in the hollow spaces on dishware and lids with hollow handles or knobs. When the moisture evaporates, pressure can build up and the item can explode. If the hollow recess is sufficiently ventilated, the item can be used.

Do not use dishware with hollow knobs or handles.

▶ Non-microwave-safe plastic dishes can suffer damage or damage the microwave oven.

Do not use any containers or cutlery made from or containing metal, aluminum foil, lead crystal glassware, temperature-sensitive plastics, wooden utensils or cutlery, metal clips, or plastic or paper-covered wire ties. Do not use bowls with milled rims, or plastic pots with the foil lid only partially removed (see the requirements specified for dishware in the section on microwave operation).

▶ Fire hazard due to containers made of flammable materials.

Plastic disposable containers must meet the requirements specified for dishware in the section on microwave operation.

Do not leave the oven unattended when heating or cooking food in disposable containers made of plastic, paper, or other flammable materials.

## IMPORTANT SAFETY INSTRUCTIONS

---

- ▶ Heat-retaining bags usually contain a thin layer of aluminum foil that reflects microwave radiation. As a result, the paper surrounding the aluminum foil can become so hot that it combusts. Do not use heat-retaining packaging, such as bags for roasted chicken, for warming food.
- ▶ If the microwave oven is used without food or the food is loaded incorrectly, the appliance can become damaged. Do not use the microwave oven to preheat dishware or to dry herbs.
- ▶ Risk of injury from the open door. You could bang into the open door. Do not leave the door open unnecessarily.

### **The following applies to stainless steel surfaces:**

- ▶ Adhesives will damage the coated stainless steel surface and cause it to lose its dirt-repellent protective coating. Do not use sticky notes, adhesive tape, or other types of adhesive on the stainless steel surface.
- ▶ Magnets can cause scratches. Do not use the stainless steel surface as a magnetic notice board.

# IMPORTANT SAFETY INSTRUCTIONS

---

## Cleaning and care

- ▶ Risk of injury due to electric shock. The steam from a steam cleaning appliance could reach live electrical components and cause a short circuit. Never use a steam cleaner for cleaning.
- ▶ Risk of burns. The appliance interior can get hot during use. Clean the appliance interior and accessories as soon as they have cooled down. Waiting too long can make cleaning unnecessarily difficult and, in extreme cases, impossible.  
Risk of fire. Under certain conditions, strong grease and gunk buildup can damage the appliance and even be dangerous. Follow the instructions on cleaning in "Cleaning and care".
- ▶ Only clean parts listed in these operating and installation instructions.
- ▶ Scratches on the door glass can cause the glass to break. Do not use abrasive cleaners, hard sponges, brushes, or sharp metal tools to clean the door glass.
- ▶ Try to prevent the interior walls being splashed with food containing salt. If this does happen, wipe it away thoroughly to avoid corrosion to stainless steel surfaces inside the oven compartment.
- ▶ In warm, moist environments, there is a higher probability of pest infestations. Ensure the oven and the area surrounding it are always kept clean.  
Damage caused by pests is not covered by the warranty.

## Accessories

- ▶ Only use original Miele accessories. Using parts or accessories from other manufacturers will invalidate the warranty, and Miele cannot accept liability.

**KEEP THE OPERATING AND INSTALLATION INSTRUCTIONS IN A SAFE PLACE AND REVIEW THEM PERIODICALLY.**

## Before using for the first time

It is important to allow the temperatures of the microwave oven and the room to equalize. Otherwise, the appliance electronics may not function correctly.

After transportation, let the unpacked microwave oven stand for approx. 2 hours at room temperature before using it.

### Risk of suffocation from packaging material

While playing, children may become entangled in packaging material (such as plastic wrapping) or pull it over their head, presenting the risk of suffocation. Keep packaging material away from children.

- Remove all packaging material when unpacking the microwave oven.

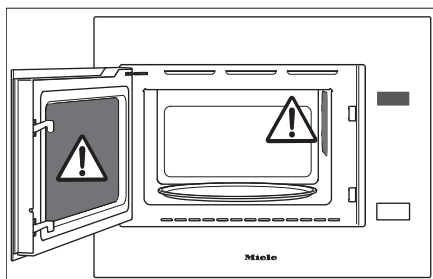

There is a cover protecting the microwave outlet on the right-hand side of the oven compartment and a layer of film protecting the inside of the door, both of which are susceptible to damage.

**Never** remove the cover from the microwave outlet and **never** remove the film from the inside of the door. Do not use the abrasive side of the dishwashing sponge to clean the cover or inside of the door.

- Check the microwave oven for any damage.

### Health risk posed by a faulty microwave oven

Operating a damaged microwave oven can result in microwave leakage and present a hazard to the user.

Do not use the microwave oven if:

- The door is warped.
- The door hinges are loose.
- Holes or cracks are visible in the casing, the door, or the oven compartment walls.

- Clean the oven compartment and all accessories with a soft sponge and warm water.

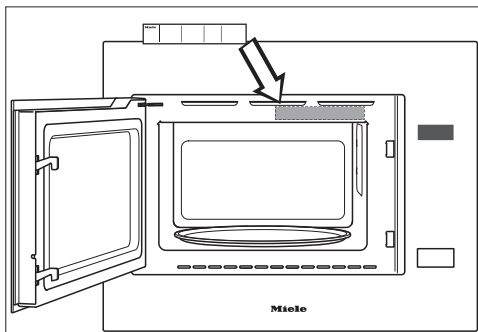

- Attach the enclosed quick guide to the frame behind the door (as illustrated), making sure it does not block any of the vents.



When installing the microwave oven, ensure that there is unhindered ventilation at the front of the appliance.

Do not block the ventilation slots with any objects.

## Installation dimensions

### Installation in a tall or base cabinet

Miele microwave ovens can be installed flush or proud. Discuss your requirements with your architect, kitchen designer, and installer.

More installation drawings are available on the Miele website.

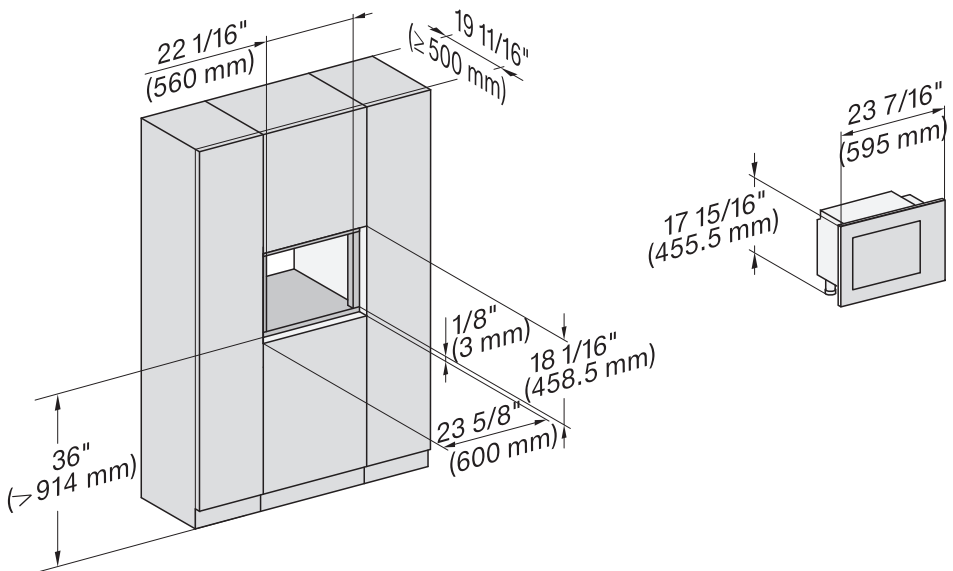

# Installation

## Side view

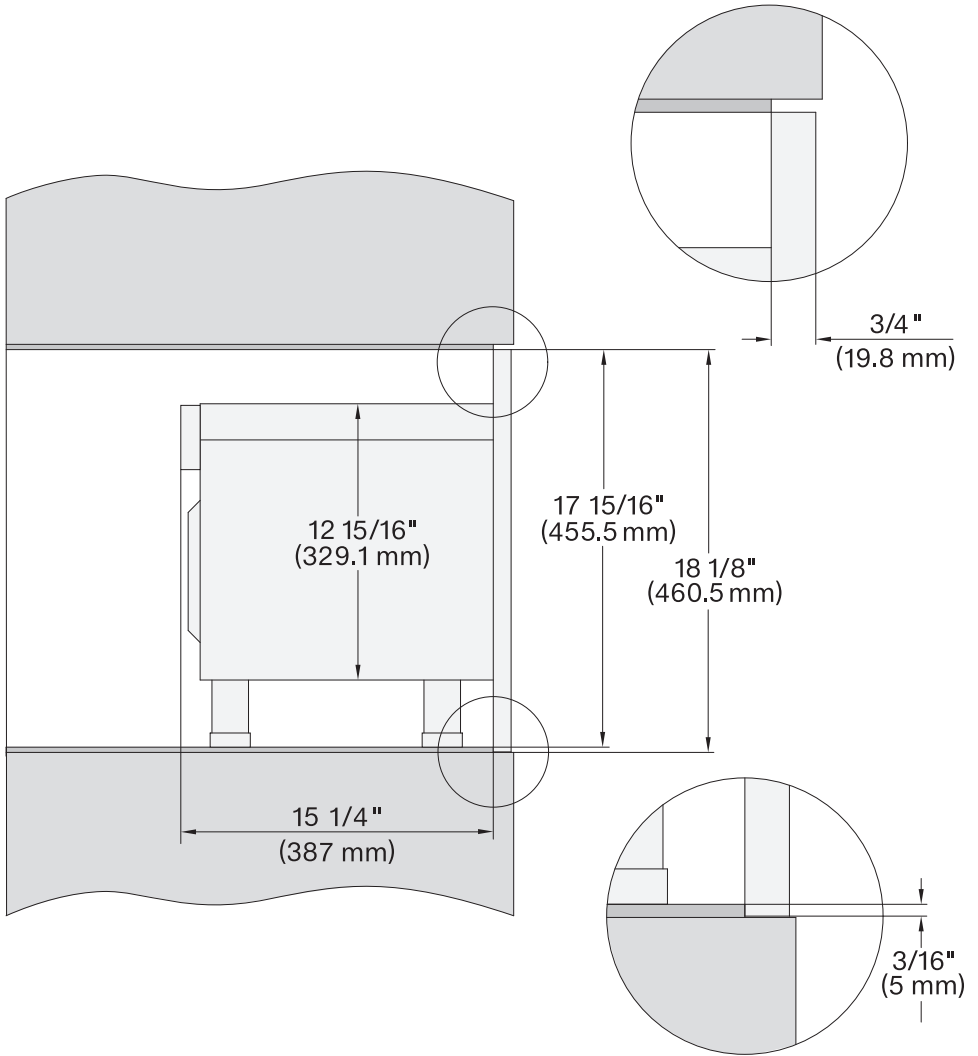

## Connections and ventilation

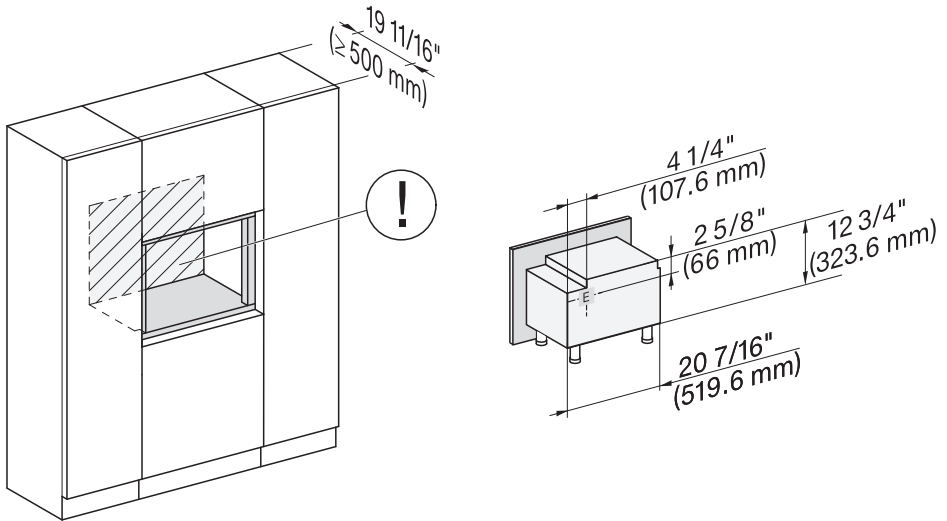

- ⓘ The outlet for the electrical connection should be accessible, e.g., in an adjacent kitchen cabinet. If the electrical connection is behind the microwave oven, the kitchen cabinet needs to be deeper than specified.

### **E** Electrical connection

# Installation

## Installing the microwave oven

For safety reasons, only use the microwave oven when it has been fully installed.

### Securing the microwave oven in the cabinet niche

The following items are supplied in the accessory pack for installing the appliance:

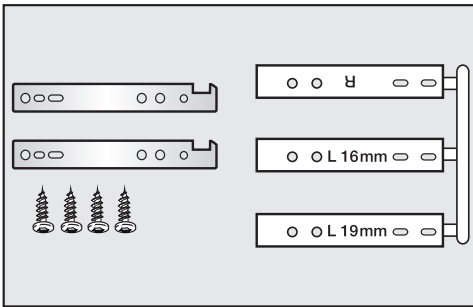

You only need to use one of the two spacers (L) (depending on whether the cabinet wall is 5/8" or 3/4" / 16 or 19 mm thick).

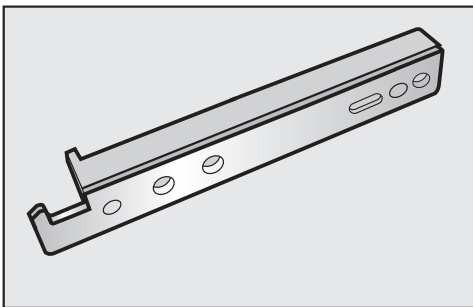

- Attach the correct left-hand spacer (L) applicable to the thickness of the cabinet wall to one of the hooks supplied.
- Attach the other hook to the right-hand spacer (R).

- Before securing the hooks, make sure that the screws are inserted where the cabinet wall is at least 5/8" (16 mm) thick.
- Draw a line on both sides of the cabinet 16 9/16" (420 mm) above the floor of the cabinet to mark the distance between the bottom of the cabinet and the lower edge of the spacer.
- Position the lower edge of the spacer on this line and align the stopper at the front of the spacer with the front of the cabinet wall.

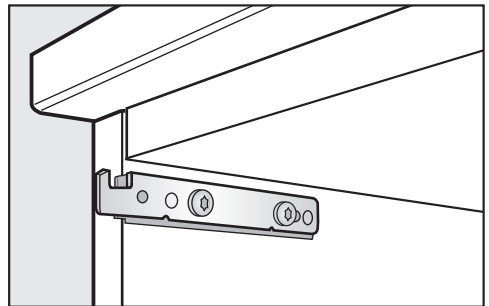

- To secure the spacers and hooks, place a screw in one of the front two holes and another in the middle of the long hole at the back. The long hole allows the position to be adjusted. The two additional holes are in case additional screws are required.
- Slide the microwave oven into the cabinet niche. Guide the power cord through the cabinet niche with the plug.

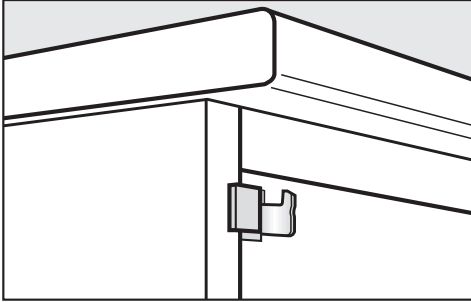

- Secure the microwave oven at the front by lifting it over the hooks and lowering it into position.
- Check that the appliance is secure by pushing lightly on the upper edge of the front frame.
- Check that it is correctly aligned.
- Connect the microwave oven to the electrical supply.

# Installation

---

## Electrical connection



Risk of injury due to electric shock.

During installation, maintenance, and repair work, the microwave oven must be completely disconnected from the power supply:

Disconnect the microwave oven from the power supply by tripping the breakers, or unplugging the power cord from the outlet. To do this, pull the plug not the cord.



Risk of injury.

Installation, repairs, and other work by unqualified persons could be dangerous. Miele cannot be held liable for unauthorized work.

Installation, maintenance, and repairs must only be carried out by a Miele authorized technician.

The connection data (voltage, frequency and max. rated load) on the data plate of the microwave oven must match the power supply in order to avoid the risk of damage to the microwave oven.

The connection data can be found on the data plate, which is visible on the front frame or at the back of the microwave oven. Compare this before connecting the appliance to the power supply. If in any doubt, consult a qualified electrician.

For safety reasons, the microwave oven may only be used when it has been fully installed.

The power cord plug must be inserted into a suitable outlet that has been installed and grounded in compliance with all applicable local codes.

**WARNING: THIS APPLIANCE MUST BE GROUNDED**

**Installer: Please pass these instructions on to the customer.**

 Risk of injury caused by a damaged microwave oven.  
Damage to the microwave oven can compromise your safety.  
Check the microwave oven for visible signs of damage. Do not use a damaged microwave oven.

The microwave oven is supplied with a plug for connection to a dedicated line and junction box.

Install the microwave oven so that the outlet is accessible. If the outlet is not accessible, make sure that a suitable means of disconnection is provided on site for each pole.

 Risk of fire by overheating.  
Installing the appliance with a power bar or an extension cord can overload the cords.  
Do not use power bars and extension cords to connect the microwave oven to the power supply.

If the power cord is damaged, it must be replaced with a special power cord of the same type (available from Miele). For safety reasons, the power cord must only be replaced by a Miele authorized technician.

The max. rated load and the fuse protection can be found in these operating and installation instructions or on the data plate. Compare this with the data of the domestic electrical supply. If in any doubt, consult a qualified electrician.

Temporary or permanent operation on an autonomous power supply system or a power supply system that is not synchronized with the grid power supply (e.g., island networks, back-up systems) is possible. A prerequisite for operation is that the power supply system complies with the specifications of EN 50160 or an equivalent standard. The function and operation of the protective measures provided in the domestic electrical installation and in this Miele product must also be maintained in isolated operation or in operation that is not synchronized with the grid power supply, or these measures must be replaced by equivalent measures in the installation. As described, for example, in the current version of VDE-AR-E 2510-2.

Do not connect the appliance to energy saving plugs or outlets. The reduction of power to the appliance caused by these devices will cause the appliance to run hot and may damage it and/or shorten its usable life.

## Electrical connection

The microwave oven is equipped with a 7 ft. (2.1 m) long power cord with a NEMA 5-15P molded plug for connection to a 120 V, 15 A, 60 Hz power supply.

**KEEP THE OPERATING AND INSTALLATION INSTRUCTIONS IN A SAFE PLACE.**

# Caring for the environment

---

## Disposal of the packing material

The cardboard box and packing materials protect the appliance during shipping. They have been designed to be biodegradable and recyclable.

Ensure that any plastic wrappings, bags, etc. are disposed of safely and kept out of the reach of children.  
Danger of suffocation!

## Disposal of your old appliance

Electrical and electronic appliances contain valuable materials. They also contain certain substances, compounds and components which were essential for the proper functioning and safe use of the equipment. Handling these materials improperly by disposing of them in your household waste can be harmful to your health and the environment. Therefore, please do not dispose of your old appliance with regular household waste and follow local regulations on proper disposal.



Consult with local authorities, dealers or Miele in order to dispose of and recycle electrical and electronic appliances. Miele assumes no responsibility for deleting any personal data left on the appliance being disposed. Please ensure that your old appliance is kept away from children until removal. Observe safety requirements for appliances that may tip over or pose an entrapment hazard.



## Microwave oven

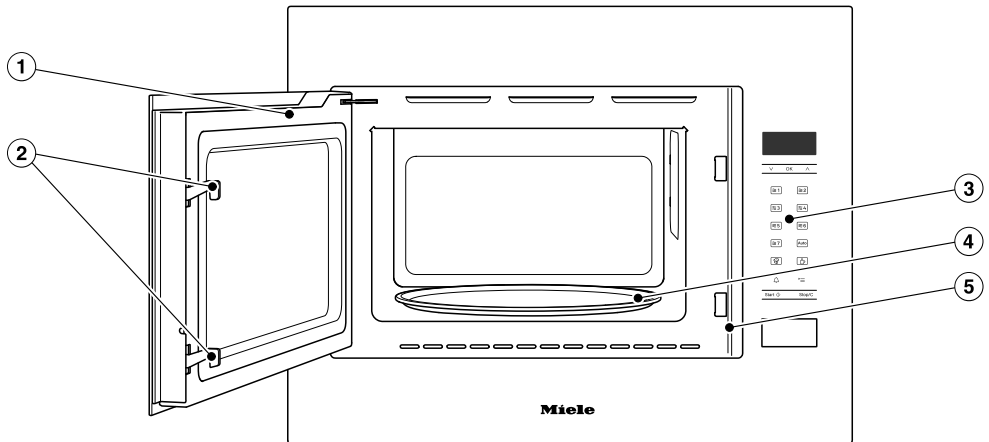

- ① Door
- ② Door lock
- ③ Controls
- ④ Turntable
- ⑤ Front frame with data plate

# Control panel

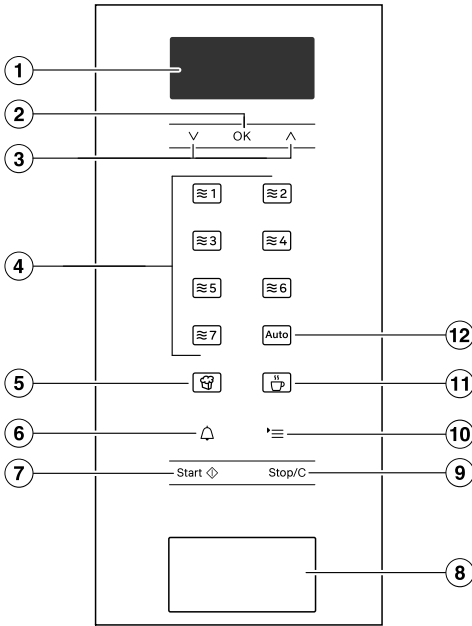

- ① Display  
For displaying the time of day and information on operation
- ② OK sensor button  
For accessing functions and saving settings
- ③ Arrow buttons ^ and v  
For changing values and settings
- ④ ≈1 to ≈7 sensor buttons  
For setting the microwave power level
- ⑤ 🍿 sensor button  
For starting the Popcorn function
- ⑥ 🔔 sensor button  
To activate or deactivate a timer
- ⑦ start ⬠ sensor button  
For starting a cooking process, for increasing the cooking duration by implements and for starting the Quick MW function
- ⑧ Door release
- ⑨ stop/C sensor button  
For interrupting a cooking process and for deleting cooking times and settings
- ⑩ ≡ sensor button  
To access settings
- ⑪ 🍵 sensor button  
For heating beverages
- ⑫ Auto sensor button  
For selecting automatic programs

## Display



## Symbols

The following symbols may appear on the display:



Symbol	Meaning
	This symbol appears when setting the time of day (see “Settings”).
	Timer
	This symbol appears when a cooking process is running (see “Operation”).
	Settings
lb g	The unit of weight used for food in the context of automatic programs and other modes (see “Settings”).
W	The unit used for the microwave power level
	This symbol flashes as soon as the appliance is ready for you to start a cooking process (see “Operation”).
P 5	Setting Status of the setting (see “Settings”)
H:H	Automatic keep-warm function “Heat and Hold” (see “Operation”)
door	This message appears if the door has been closed for 20 minutes or longer. You cannot start a program (see “Operation”).
U--o	The system lock prevents the microwave oven being switched on by mistake (see “Operation – System lock”).
DE5	Demo mode (see “Settings”)

# Control panel





## Sensor buttons

The sensor buttons react to touch. Every tap of a sensor button is confirmed with an audible keypad tone. You can turn this keypad tone off using '≡ | P 3.

For information on the functions and operating modes, see "Operation", "Settings", "Automatic Programs" and "Further applications".

Sensor button	Function
OK	By selecting this sensor button you can access functions such as the timer, save changes to values or settings, or confirm instructions.
∨ ∧	Use the arrow buttons to change values and settings.
⊞1 to ⊞7	Use these sensor controls to select the required microwave power level. The power for each level appears on the display in watts.
	Use this sensor control to start the Popcorn function. The cooking process runs at microwave power level power level ⊞7 (900 W) for a cooking duration of 2:55 minutes (see section "Popcorn"). To set the cooking duration, select '≡   P 10. This function can only be used when no other cooking processes are in use.
	You can use this sensor button at any point to set a timer (e.g., when boiling eggs) (see "Timer").
Start 	Use this sensor button to start a cooking process and to increase the cooking duration by 30 or 60 seconds (depending on the microwave power level). You can also start the Quick MW function. The cooking process runs with maximum power level ⊞7 (900 W) and a cooking duration of 1 minute (see „Quick MW“). Touching the sensor button repeatedly increases the cooking duration in increments. This function can only be used when no other cooking processes are in use.

## Control panel

Sensor button	Function
Stop/C	<p>Use this sensor button to interrupt a program and to stop the signal after a cooking process is completed.</p> <p>You can also delete a timer, leave the settings menu or switch off the microwave oven.</p>
	<p>This sensor control allows you to reheat the contents of up to 6 cups. The cooking process runs at the maximum microwave power level of  (900 W). The actual duration depends on the number of cups set and is adjusted automatically (see “Operation” – “Reheat drinks”).</p> <p>To set the quantity of liquid inside each cup, select    P //.</p>
	<p>Use this sensor button to access the settings.</p>

# Microwave operation

---

## How it works

The microwave oven contains a magnetron that converts electrical energy into electromagnetic waves (microwaves). These microwaves are distributed evenly throughout the oven compartment and are also reflected by the metal walls inside the oven.

The microwaves penetrate the food from all sides. Food consists of many molecules. When subjected to microwave energy, these molecules (particularly the water molecules) start to oscillate. This heats the food from the outside to the inside. The more water a food contains, the faster it is reheated or cooked.

## Advantages of the microwave oven

- Food can generally be cooked with little or no liquid or cooking oil.
- The times for defrosting, reheating, or cooking are shorter than with a cooktop or oven.
- Vitamins, minerals, natural color, and taste of the food are generally retained.

## Suitable dishware

In order for microwaves to reach the food, they must be able to penetrate the dishware being used. Microwaves can pass through porcelain, glass, cardboard, and plastics, but not metal. Therefore, do not use metal containers or dishware that contains metal. Metal reflects the microwaves which can create sparks and the microwaves are not absorbed by the metal.

 Danger of injury from increased pressure in sealed containers or bottles

Pressure can build up when reheating food or drinks in sealed containers or bottles, which can cause them to explode.

Never cook or reheat solid or liquid food in sealed containers or bottles. Open containers beforehand and, with baby bottles, remove the screw top and teat.

 Risk of fire due to unsuitable dishware

Dishware that is not microwave-safe can be destroyed and may damage the microwave oven.

Only use microwave-safe dishware in the microwave oven.

The material and shape of dishware used affect reheating and cooking durations.

Heat distribution is more even in round and oval-shaped flat containers. Food is reheated more evenly in these containers than in square ones.

## Suitable dishware

 Fire hazard due to flammable materials

Disposable containers made out of plastic, paper, or other flammable materials can ignite, causing damage to the microwave oven.

Do not leave the microwave oven unattended when reheating or cooking food in disposable containers made of plastic, paper, or other flammable materials.

You can use the following dishware and materials:

- Heat-resistant glass and ceramic glass  
Exception: crystal glass as it contains lead and may crack.
- Porcelain
  - Without metallic decoration  
Metallic decoration (e.g., gold rims or cobalt blue) can cause sparking.
  - Without hollow knobs and handles  
Moisture can gather in hollow knobs and handles. When the moisture evaporates, pressure can build up and the item can explode.
- Unpainted stoneware and stoneware with underglaze paints

 Danger of injury caused by hot dishware.

Stoneware can get hot.

Use pot holders when using stoneware.

- Plastic dishware and disposable plastic containers

**Tip:** To protect the environment, avoid the use of disposable containers.

Plastic dishware and bags that are not heat-resistant may melt and fuse with the food inside.

Only use plastic dishware or bags that are heat-resistant. Plastic dishware and bags must be heat-resistant to a minimum of 230°F (110°C).

- Microwave-safe plastic dishware  
Special plastic dishware designed for use in microwave ovens is available from retail outlets.
- Styrofoam dishware  
For briefly heating food.
- Plastic boiling bags  
For cooking and reheating. They should be pierced before use. The holes allow the steam to escape. This prevents a build-up of pressure from forming and the bag from bursting. There are also special bags available for steam cooking which do not need to be pierced. Please follow instructions given on the packet.
- Roasting bags and tubes  
Please follow the manufacturer's instructions.

 Risk of fire due to metal parts.

Metal parts such as metal clips or plastic and paper ties that have wire running through them can heat flammable materials until they burn.

Do not use metal clips or plastic and paper ties containing wire.

# Microwave operation

---

**Tip:** Metallic dishes are not very suitable for use in the microwave oven. Metal reflects microwaves and obstructs the cooking process.

Using aluminum foil trays and aluminum foil can cause crackling and sparks.

Place aluminum foil trays on the turntable.

Aluminum foil and aluminum foil trays must not touch the oven compartment walls and must remain at least 3/4" (2 cm) from the walls at all times.

- Aluminum foil trays without lids for defrosting and reheating TV dinners  
The food is only heated from the top. If you remove the food from the aluminum foil container and transfer it to dishware suitable for use in a microwave oven, the heat distribution will generally be more even.
- Metal skewers or clips  
The size of the cut of meat must be much larger than the metal skewers and clips.

## Unsuitable dishware

Moisture can collect in the hollow spaces on dishware and lids with hollow handles or knobs. When the moisture evaporates, pressure can build up and the item can explode. If the hollow recess is sufficiently ventilated, the item can be used.

Do not use dishware with hollow knobs or handles for cooking.

Do **not** use the following dishware and material:

- Wire racks are **not** at all suitable for use in the microwave.
- Metal containers
- Aluminum foil  
Exception: in the case of unevenly shaped cuts of meat – e.g., poultry – small pieces of aluminum foil may be used to cover thin parts for the last few minutes of the process to ensure even defrosting, reheating, or cooking.
- Metal clips, or plastic or paper ties containing wire
- Plastic containers where the aluminum lid has not been completely removed
- Crystal glass
- Utensils and dishware with metallic decoration (e.g., gold rims, cobalt blue)
- Dishware with hollow handles
- Plastic dishware made of melamine  
Melamine absorbs microwave energy and gets hot.



When purchasing plastic dishware, make sure that it is suitable for use in a microwave oven.

- Wooden dishes  
Water contained in wood evaporates during the cooking process. This causes the wood to dry and crack.

## Testing dishware

Unsuitable dishware can cause sparks or crackling noises during microwave operation. If you are not sure whether glass, porcelain, or stoneware dishware is suitable, test it.

This test cannot be used to check whether items with hollow grips or handles are suitable for use.

- Place the empty dishware on the turntable.
- Close the door.
- Set the microwave power level to  $\approx 7$  (900 W) and the cooking duration to 30 seconds.
- Start the process.
- Observe the dishware during the entire duration.
- Immediately open the door if there are sparks or crackling noises.

If there are sparks or if you can hear crackling noises, the tested dishware is not suitable for microwave use.

## Cover

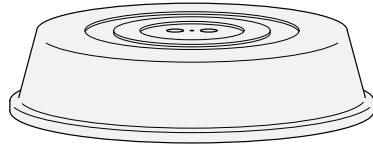

**Tip:** Covers are available from retail outlets.

- A cover prevents too much steam escaping, especially when cooking foods which need longer to cook.
  - It speeds up the process of heating the food.
  - It prevents food from drying out.
  - It helps keep the oven compartment clean.
- When cooking in the microwave, use a microwave-safe cover made of glass or plastic.

**Tip:** Alternatively, use a cling film suitable for use in a microwave oven. Heat can cause normal cling film to melt and fuse with the food.

The cover should not form a seal with the container. If the container has a narrow diameter, the steam may not be able to escape. The cover could get too hot and start to melt.

Use containers with a sufficiently large diameter.

- Do **not** use a cover for heating or reheating the following types of food:
  - Food coated in breadcrumbs
  - Food which requires a crisp finish, e.g., toast

## Before first use

---

 Danger of injury caused by hot surfaces

The microwave oven gets hot during operation.

For safety reasons, the microwave oven may only be used when it has been fully installed.

The microwave oven will switch on automatically when it is connected to the electrical supply.

### Setting the time of day

The time of day is shown in 12-hour clock format.

When you connect the appliance to the electrical supply, the  symbol and *12:00* will flash on the display.

- Use the  $\wedge$  and  $\vee$  arrow keys to set the hour.
- Confirm with *OK*.
- Use the  $\wedge$  and  $\vee$  arrow keys to set the minutes.
- Confirm with *OK*.

The set time is now applied.

You can also display the time of day in 24-hour format by going to the *P 4* setting and selecting *24* (see “Settings – Changing settings”).

## Settings overview

Setting	Status
<i>P 1</i> <b>Time of day</b>	<i>12:00*</i> Use the arrow keys to set the hour and then the minutes.
<i>P 2</i> <b>Audible signal</b>	<i>5 0</i> The audible signal is <b>switched off</b> .
	<i>5 1*</i> The audible signal is <b>switched on</b> .
<i>P 3</i> <b>Keypad tone</b>	<i>5 0</i> The keypad tone is <b>switched off</b> .
	<i>5 1*</i> The keypad tone is <b>switched on</b> .
<i>P 4</i> <b>Clock format</b>	<i>24</i> The time of day is shown in the <b>24-hour format</b> .
	<i>12*</i> The time of day is shown in the <b>12-hour format</b> . If you change the clock from a 12-hour clock to a 24-hour clock after 1:00 pm, you will need to update the hour accordingly.
<i>P 5</i> <b>Night dimming</b>	<i>5 0*</i> Night dimming is <b>switched off</b> .
	<i>5 1</i> Night dimming is <b>switched on</b> . The time of day display is switched off between the hours of 11 pm and 5 am.
<i>P 6</i> <b>Unit of weight</b>	<i>5 0*</i> Food weight is displayed in pounds (lb).
	<i>5 1</i> Food weight is displayed in grams (g).
<i>P 7</i> <b>Automatic keeping warm function</b>	<i>5 0</i> The automatic keeping warm function is <b>switched off</b> .
	<i>5 1*</i> The automatic keeping warm function is <b>switched on</b> (see “Operation – Automatic keeping warm function – <i>H:H</i> ”).

\* Factory default

# Settings

Setting	Status
<i>P 8</i> <b>Quick MW</b>	<i>900 W*</i> The maximum power can be changed from <i>80 W</i> up to <i>900 W</i> .  <i>01:00*</i> The cooking duration of <i>01:00</i> minutes can be increased up to a maximum of <i>10:00</i> minutes, depending on what power level has been set (see “Quick MW”).
<i>P 9</i> <b>Oven compartment query <i>door</i></b>	<i>5 0</i> The <i>door</i> message will not appear on the display.  <i>5 1*</i> The <i>door</i> message will appear on the display if the door has not been opened for about 20 minutes. You will not be able to start the cooking process (see “Operation – Oven compartment query – <i>door</i> ”).
<i>P 10</i> <b>Popcorn</b>	<i>2:55*</i> The cooking duration of <i>2:55</i> minutes can be adjusted within the range of <i>2:30 – 3:30</i> minutes (see “Popcorn”).
<i>P 11</i> <b>Cup size</b>	<i>0:08*</i> The cup size of <i>0:08</i> liquid oz can be adjusted within the range of <i>0:03 – 0:10</i> liquid oz (see “Operation – Reheat drinks”).
<i>P 12</i> <b>Demo mode <i>NES</i></b>	<i>5 0*</i> Select <i>5 0</i> and press OK for approx. 4 seconds. - - - appears briefly to indicate that Demo mode has been <b>deactivated</b> .  <i>5 1</i> Select <i>5 1</i> and press OK for approx. 4 seconds. <i>NES</i> appears briefly to indicate that Demo mode has been <b>activated</b> .  The microwave oven cannot be operated. Do not activate this setting for domestic use.
<i>P 0</i> <b>Factory default settings</b>	<i>5 0</i> The settings will <b>not</b> be reset.  <i>5 1*</i> Any settings that have been altered will be reset to the factory default settings.

\* Factory default

## Changing settings

You can personalize your microwave oven by adapting the factory default settings to suit your requirements.

To access the settings, select the  $\text{≡}$  sensor control (see “Settings overview”).

You cannot change settings while a cooking process is in progress.

- Select the  $\text{≡}$  sensor control.

*P I* will appear on the display.

- If you want to change another setting, select the appropriate number with the  $\wedge$  or  $\vee$  arrow keys.

- Confirm with *OK*.

The setting is selected and the current status appears, e.g., *5 0*.

To switch from the currently selected setting to a different one, press *OK* and then select the setting you want.

- Set the desired status using the  $\wedge$  or  $\vee$  arrow keys.

- Confirm with *OK*.

The status is saved and the setting appears again.

- To change additional settings, proceed in the same way.
- If you do not want to change any further settings, select  $\text{≡}$ .

The settings will remain in the memory in the event of a power failure.

# Operation

## Tips for cooking with the microwave

- You can choose from 7 different microwave power levels. The higher the power level, the more microwaves reach the food.
- When heating up foods that cannot be stirred or turned during cooking, or foods with very different consistencies, it is best to use a lower microwave power level. This ensures that the heat is distributed evenly.  
Extend the cooking duration accordingly to cook the food properly.
- Food taken straight from the refrigerator takes longer to defrost, reheat, and cook than food which has been kept at room temperature.
- Fresh vegetables contain more water and cook more quickly than stored vegetables.
- Frequent stirring or turning heats the food more evenly, and it is therefore ready in less time.
- The more food you place inside the oven, the longer it will take to cook (twice the amount = almost twice as long). Reducing the quantity of food shortens the cooking duration.
- The shape of the dishware and material from which it is made may affect the cooking duration (see "Microwave operation – Suitable dishware").

## Using the turntable

Placing food directly on the floor of the oven can cause damage to the microwave oven.

**Always** use the turntable, placing the dishware on top.

The turntable begins turning automatically whenever you start a process. This ensures that the food gets defrosted, reheated, or cooked evenly.

### Tips

- Do not place food directly on the turntable when cooking, reheating, or defrosting.
- Make sure that the dishware is smaller than the turntable.
- Turn or stir food during cooking so that it heats up evenly.

## Starting a cooking process

- Place the dishware containing the food on the turntable.
- Press the door shut.

If the door has not been shut properly, you will not be able to start a cooking process.

- Select the required microwave power level.

The  symbol will appear on the display together with the set microwave power level.

00:00 will appear on the display and the minutes will flash.

- Use the ^ and v arrow keys to set the minutes.

- Confirm with **OK**.

The minutes set are saved and the seconds flash.

- Use the  $\wedge$  and  $\vee$  arrow keys to set the seconds.
- Confirm with **OK**.

With microwave power level  $\approx 7$  (900 W), the cooking duration is limited to 15 minutes.

The other microwave power levels allow you to set a cooking duration of up to 90 minutes.

Operating the microwave continuously at full power may result in the power level being reduced by the overheating protection (see “Frequently Asked Questions”).

- Select the start  $\diamond$  sensor control.

The cooking process starts.

At the end of the cooking duration, an audible signal will sound. If you do not respond, the appliance will emit another audible signal after 5, 10, 15, and 20 minutes to remind you.

- At the end of the cooking process, select the stop/C sensor control.

You can also keep the food warm at the end of the cooking process (see “Automatic keeping warm function *H:H*”).

- Take the food out of the oven.

## Changing the microwave power level

You can use sensor controls  $\approx 1$  through  $\approx 7$  to change the microwave power level during a cooking process.

- Select the required microwave power level.

The cooking process continues running without interruption for the remainder of the cooking duration with the new microwave power level.

## Changing the cooking duration

- Select the  $\wedge$  or  $\vee$  arrow key.

The minutes will flash.

- Adjust the cooking duration by using the  $\wedge$  and  $\vee$  arrow keys to change the minutes and then the seconds.
- Confirm each with **OK**.
- Press the start  $\diamond$  sensor control to resume the cooking process.

# Operation

## Interrupting and resuming a cooking process

You can interrupt a cooking process (and resume it) at any time.

- Open the door during the cooking process or select the *stop/C* sensor control.

The cooking process is interrupted and the cooking duration is paused.

- To resume the cooking process, close the door and select the *start*  sensor control.

The cooking process resumes and the cooking duration continues to count down.

## Canceling a cooking process

- Press the *stop/C* sensor control twice in a row.



## Automatic keeping warm function – *H:H*

At the end of a cooking process at microwave power level  (450 W) or higher, the automatic keeping warm function *H:H* will switch on automatically if the door remains closed and no sensor controls are pressed.

This will happen after approx. 2 minutes and will keep the food warm for up to 15 minutes by using microwave power level  (80 W). The appliance will emit an audible signal after 5, 10, and 15 minutes.

, *80 W*, and *H:H* (Heat and Hold) appear on the display.

You can adjust this function with the *P 7* setting.

The automatic keeping warm function cannot be combined with the Popcorn  and Reheat drinks  functions.

## Oven compartment query – *door*

Operating the microwave oven while empty can damage it.

Make sure that some food has actually been placed inside the oven before starting a cooking process.

The *door* message appears to remind you that the microwave oven must not be used without any food inside it.

If you attempt to start a cooking process without opening the door first, the *door* message will appear on the display.

There may not be any food inside the oven, given that you have not opened the door for a long time (approx. 20 minutes).

Open and close the door, and then select the *start*  sensor control.

You can adjust this function with the *P 9* setting.





## Reheat drinks



This function allows you to reheat the contents of up to 6 cups. The cooking process runs at the maximum microwave power level of  (900 W).

The actual duration depends on the number of cups set and is adjusted automatically. The microwave power level is set and cannot be modified.

You can use the *P11* setting to adjust the cup size of 0:08 liquid oz to a value within the range of 0:03 – 0:10 liquid oz.

- Place the cup or cups containing the liquid inside the oven.
- Select the  sensor control.

 and *l* will appear on the display. The  will flash.

- To reheat several cups of liquid at once, use the  $\wedge$  and  $\vee$  arrow keys or the  sensor control to select the relevant number of cups.
- Select the Start  sensor control.

The cooking process starts.

You can interrupt the cooking process at any time with the stop/C sensor control.

Select the Start  sensor control to resume the cooking process or the stop/C sensor control to cancel it.

## Switching the system lock on and off

The system lock prevents the microwave oven from being switched on inadvertently.

The timer can still be used when the system lock is active. If you attempt to start a cooking process, the  key symbol will appear on the display.

In the event of a power failure, you will have to reactivate the system lock.

- Press and hold *OK* for approx. 6 seconds.

The seconds will count down to zero.

You will then hear an audible signal and the  key symbol will appear on the display.

The  key symbol will go out after a short time.

All appliance functions are now locked. When the system lock is activated, the only function you can use is the timer (see “Timer”).

- To deactivate the system lock, press and hold *OK* for approx. 6 seconds until you hear an audible signal.

You can now use all the functions available on the microwave oven.

# Timer

---

## Using the Timer function

The  $\triangle$  timer can be used to time other activities in the kitchen, e.g., boiling eggs.

The timer can also be used at the same time as a cooking process for which automatic start and finish times have been set (e.g., as a reminder to stir the food or add seasoning, etc.).

- The maximum timer duration that can be set is 90 minutes and 00 seconds.

## Setting the timer

Example: you want to boil some eggs and set a timer of 6 minutes and 20 seconds.

- Select the  $\triangle$  sensor control.

The  $\triangle$  symbol and  $00:00$  will appear on the display. The minutes will flash.

- Use the  $\wedge$  and  $\vee$  arrow keys to set the minutes to  $06$ .
- Confirm with *OK*.

The minutes set are saved and the seconds flash.

- Use the  $\wedge$  and  $\vee$  arrow keys to set the seconds to  $20$ .
- Confirm with *OK*.

The timer duration is now saved.

If **no** cooking process is taking place at the same time, the  $\triangle$  symbol will be shown together with the running timer instead of the time of day.

If a cooking process is taking place at the same time, the timer will count down in the background.

- To see how much time has elapsed so far, select the  $\triangle$  sensor control while the cooking process is running.

At the end of the timer duration,  $\triangle$  will flash, the time will start counting up, and an audible signal will sound.

- Select the  $\triangle$  sensor control.

The audible signal will stop and the symbols on the display will go out.

## Changing the timer duration

- Select the  $\triangle$  sensor control.

The  $\triangle$  symbol will appear on the display together with the timer duration.

- Use the  $\wedge$  and  $\vee$  arrow keys to change the timer duration.
- Confirm with *OK*.

The altered timer duration is now saved.

## Deleting the timer

- If a cooking process is running at the same time, select the  $\triangle$  sensor control.

The  $\triangle$  symbol will appear on the display together with the timer duration.

- Select the *Stop/C* sensor control.

The timer is deleted.

If **no** cooking process is running at the same time, press the *Stop/C* sensor control to delete the timer directly.

These functions can only be used when no other cooking processes are in use.

## Quick MW

If you select the **Start**  sensor control, the microwave starts with a set microwave power level and cooking duration, e.g., to reheat a drink.

The maximum microwave power level of  (900 W) and a cooking duration of 1 minute are set by default.

You can change the microwave power level and the cooking duration with the *P B* setting. The maximum cooking duration that can be set depends on the microwave power level selected:

- The following microwave power levels can be selected: 80 W, 150 W, 300 W, 450 W, 600 W, 750 W, or 900 W.
- The maximum cooking duration that can be set depends on the microwave power level selected:  
80–300 W: maximum 10 minutes  
450–900 W: maximum 5 minutes

- Select the **Start**  sensor control. Touching it repeatedly increases the cooking duration in increments.

The time left will appear on the display.

You can interrupt the cooking process at any time with the **Stop/C** sensor control.

Select the **Start**  sensor control to resume the cooking process or the **Stop/C** sensor control to cancel it.

At the end of the cooking process, an audible signal will sound.

## Popcorn

This function is suitable for making microwave popcorn.

If you select the  sensor control, the microwave starts with a set microwave power level and cooking duration.

Microwave popcorn is commercially available in packs of various sizes. This function is designed for a pack size of approx. 3.5 oz (100 g). A microwave power level of  (900 W) and a cooking duration of 2:55 minutes are set by default.

To accommodate different pack sizes, you can use the *P 10* setting to adjust the cooking duration within the range of 2:30–3:30 minutes. The microwave power level is set and cannot be modified.

This function is not suitable for making popcorn from kernels. Only use this function with products that are specifically labeled as microwave popcorn.

If the pack containing the popcorn comes into contact with the wall of the oven interior and gets stuck there, there is a risk of heat building up.

Place the pack **centrally** on the turntable so that it has enough room to expand.

## Quick MW and Popcorn

---

- Place the microwave popcorn on the turntable according to the instructions on the packaging.
- Select the  sensor control.

The time left will appear on the display. You will be able to hear the corn popping.

- Stop the cooking process before the end if the popping noises become infrequent. Follow the instructions on the pack.



Risk of injury caused by hot popcorn

The pack containing the microwave popcorn will be very hot at the end of the cooking process.

Use pot holders to remove the popcorn.

With the wide range of automatic programs, you can achieve excellent results with ease.

The automatic programs are weight-dependent. The *P E* setting allows you to set the unit of weight to either pounds (lb) or grams (g) (see “Settings”).

If you select pounds (lb) as the unit of weight, the weight of the food will be shown on the display in the format “lb:oz” (e.g., *1:02* for 1 lb 2 oz).

## Using automatic programs

- Select the **Auto** sensor control.

The  symbol and *R I* will appear on the display.

- Use the  $\wedge$  and  $\vee$  arrow keys to select the required automatic program (see “Overview of automatic programs”).

- Confirm with *OK*.

The display will show the lowest food weight supported by the automatic program.

The  start symbol will flash together with either lb or g.

- Use the  $\wedge$  and  $\vee$  arrow keys to set the weight.
- Select the *Start*  sensor control.

The cooking process starts. The cooking duration depends on which automatic program is selected and the weight that is set.

About halfway through the cooking duration, an audible signal will sound to remind you to turn or stir the food.

- Open the door to interrupt the cooking process.
- Turn or stir the food.
- Close the door and select the *Start*  sensor control.

The cooking process will resume.











- To increase the cooking duration of the automatic program in increments, press the *Start*  sensor control repeatedly until the required time appears on the display.

At the end of the cooking duration, an audible signal will sound.

At the end of the cooking process, allow the food to stand at room temperature for approx. 2 minutes. This standing time allows the heat to spread more evenly throughout the food.

# Automatic Programs

## Overview of automatic programs

Auto		Category	Food	Weight [lb:oz]		Weight [g]	
				Minimum	Maximum	Minimum	Maximum
A 1		* Defrost	Steak, chops	0:08	2:03	200	1000
A 2			Ground meat	0:08	2:03	200	1000
A 3			Chicken	2:01	3:15	900	1800
A 4			Cake	0:04	3:01	100	1400
A 5			Bread	0:04	2:03	100	1000
A 6		* Defrost and Cook	Vegetables	0:04	1:05	100	600
A 7			TV dinners that can be stirred	0:11	2:03	100	1000
A 8			Bakes/gratin	0:08	1:05	200	600
A 9		Cook	Vegetables	0:04	1:05	100	600
A 10			Potatoes	0:04	1:12	100	800
A 11			Fish in sauce	1:02	3:05	500	1500

## Using automatic program *R 9* for vegetables

Automatic program *R 9* is suitable for cooking fresh vegetables.

- Select  | *R 9*.
- Follow the instructions on the display.

About halfway through the cooking duration, an audible signal will sound to prompt you to turn or stir the food.

### Tips

- Wash the vegetables and prepare them as per the recipe.
- Place the vegetables and other ingredients inside a cooking container and add 3–4 tbsp water.
- Season the vegetables as per the recipe or to taste.
- Enter the weight of the food, including the water. When cooking vegetables in sauce, the weight entered must include the sauce.
- Place the food on the turntable, ensuring it is covered. For this, use a cover or microwavable film, for example.

## Recipes

Here are some recipes for you to try with the automatic programs.

For best results, we recommend using the exact quantities and accessories listed in the recipes.

If the weights given for the relevant programs are exceeded, the food will not be sufficiently cooked, so please observe the guidelines.

## Potatoes in a curry sauce

Serves 3

### Ingredients

1 onion | diced  
1 tbsp butter  
1 lb (500 g) potatoes, waxy | diced  
1–2 tbsp curry powder  
1 cup (250 ml) vegetable stock  
1/4 cup (50 ml) heavy cream  
1/4 lb (125 g) peas, frozen  
Salt  
Pepper

### Accessories

Bowl, microwave-safe  
Total time required: 35 minutes

### Method

Mix together all the ingredients in a bowl.

Place the food on the turntable, ensuring it is covered, and cook.

When a signal sounds, stir the vegetables immediately.

### Setting

Program:  | *R 10*  
Weight: 1 3/4 lb (800 g)

# Automatic Programs

---

## Salmon in white wine sauce

Serves 4

### Ingredients

1.5 lb (700 g) salmon fillet | cut into four fillets and ready to cook  
1 lemon | juiced and sliced  
3 garlic cloves | minced  
2 oz (50 g) butter | cubed  
1 cup (200 ml) white wine  
1 bunch dill | chopped coarsely  
1 bunch parsley | chopped coarsely

### Accessories

Casserole dish, microwave-safe  
Total time required: 25 minutes

### Method

Place all ingredients in the casserole dish.

Place the food on the turntable, ensuring it is covered, and cook.

### Setting

Program:  | *R 11*

Weight: 2.4 lb (1,100 g)

## Carrots in a chervil cream sauce

Serves 2

### Ingredients

3/4 lb (350 g) carrots | sliced  
1 tsp butter  
1/4 cup (50 ml) vegetable stock  
1/4 lb (75 g) crème fraîche  
1 tbsp white wine  
1/2 tsp sugar  
1/2 tsp salt  
1 tbsp cornstarch  
1/2 tsp mustard  
1–2 tbsp chervil, fresh, chopped  
Pepper

### Accessories

Bowl, microwave-safe  
Total time required: 35 minutes

### Method

Place the carrots in a bowl along with the butter and vegetable stock.

Mix together the crème fraîche, white wine, sugar, salt, cornstarch, mustard, and chervil. Season with pepper to taste. Add the sauce to the vegetables and stir.

Place the food on the turntable, ensuring it is covered, and cook.

When a signal sounds, stir the vegetables immediately.

### Setting

Program:  | *R 9*

Weight: 1.2 lb (525 g)





This section provides information on the following applications:

- Defrost
- Reheat
- Cooking
- Canning

### Defrost

Gentle defrosting of frozen food means that the vitamins and minerals are generally retained.

- Select an automatic program from *A 1* to *A 8* (see “Automatic programs – Overview of automatic programs”) or use the following microwave power levels:
  - Microwave power level  (80 W)  
For defrosting very delicate food, e.g., cream, butter, gateau, buttercream cake, and cheese
  - Microwave power level  (150 W)  
For defrosting everything else
- When using this mode, enter the weight or – if you have selected a microwave power level – the defrosting duration.

Always observe USDA/CFIA food safety guidelines.

 Risk of infection from bacteria.

Bacteria such as salmonella can cause life-threatening food poisoning.

It is particularly important to observe food hygiene rules when defrosting fish and meat, and in particular when defrosting poultry.

Do not use the liquid produced during defrosting.

Process the food as required as soon as it has been defrosted.

### Tips for defrosting

- Only use dishware that is microwave safe.
- Remove the frozen food from its packaging and defrost uncovered.
- Place frozen meat on an upturned plate inside a glass or porcelain container. This way the frozen food will not be lying in the defrosted liquid.
- Turn, separate, or stir the food about halfway through the defrosting time.
- Meat, poultry, or fish does not need to be fully defrosted before cooking. Defrost until the food has started to thaw. The surface will then be sufficiently thawed to take herbs and seasoning.

# Additional applications

## Tips for combining the Defrost function with subsequent reheating/cooking

Frozen food can be defrosted and then reheated or cooked in the microwave as well.

The time required depends on the nature of the food, its initial temperature, and the amount to be cooked.

- Take the food out of its packaging and place it inside a microwave-safe dish.
- Cover the food.  
Exception: chopped steak should be left uncovered during cooking.
- Select microwave power level  $\approx 7$  (900 W) first, followed by microwave power level  $\approx 4$  (450 W).
- If the food has a high water content (e.g., soups and vegetables), stir it several times during cooking.
- Carefully separate and turn slices of meat halfway through.
- Turn pieces of fish at the halfway stage.
- Allow food to stand at room temperature after defrosting and then reheating/cooking it. This standing time allows the heat to spread more evenly throughout the food.

## Reheat

It is essential that the information in “IMPORTANT SAFETY INSTRUCTIONS – Correct use” is observed.

Always observe USDA/CFIA food safety guidelines.

 Danger of injury caused by hot food.

If food for babies and children is heated at too high a temperature, they can burn themselves.

Only heat food for babies and children for 30–60 seconds at microwave power level  $\approx 4$  (450 W). After heating food – especially food for babies and small children – stir the food or shake the container, and then taste the food to make sure it will not burn the mouths of the children.

 Danger of injury from increased pressure in sealed containers or bottles

Pressure can build up when reheating food or drinks in sealed containers or bottles, which can cause them to explode.

Never cook or reheat food or liquids in sealed containers or bottles. Open containers beforehand and, with baby bottles, remove the screw top and teat.

## Additional applications

Danger of injury caused by hot liquids.

When using the microwave oven to heat food, particularly liquids, the boiling point may be reached without the typical bubbles being produced. The liquid does not boil evenly throughout.

This boiling delay can result in the liquid boiling over explosively. Take care when taking the container out of the oven, as the hot liquid can cause severe scalding. Under certain circumstances, the pressure can be so high that the door bursts open.

Stir liquids well before heating or cooking.

After heating, wait at least 20 seconds before removing the container from the oven.

In addition, you can place a glass rod or similar item, if available, in the container during the heating process.

Food with a thick skin or peel, such as tomatoes, sausages, potatoes, and eggplant can burst when heated or cooked.

Pierce or score the skin of these foods several times to allow steam to escape.

Eggs heated in their shell can burst, even after they have been removed from the oven.

Eggs can only be cooked in their shells in a specially designed egg-boiling device. Do not reheat hard-boiled eggs in the microwave oven.

 Danger of burning due to hot surfaces.

The microwave oven gets hot during operation. There is a risk of burning yourself on the hot oven compartment, dishware, or food. Spots of condensation may form on the bottom of the dishware.

Wear oven gloves when reaching into the hot oven compartment and when removing the dishware.

### Tips on reheating















- Only use dishware that is microwave safe.
- Always cover food when reheating it, except when reheating food coated in breadcrumbs.
- The time required depends on the nature of the food, its initial temperature, and the amount to be cooked. For example, food taken straight from the refrigerator takes longer to reheat than food which has been kept at room temperature. Take note of the standing times.
- Turn, separate, or stir the food several times. Stir the food from the outside toward the middle, as food heats up more quickly at the edges.
- The purpose of the standing time is to allow the food to develop a more even temperature.
- After reheating, allow the food to stand at room temperature for a few minutes to enable the heat to spread more evenly throughout the food.

To reheat drinks, use the  sensor control (see “Operation – “Reheat drinks”).

# Additional applications

## Examples of heating food

The information provided in this chart is intended as a guide only.

Food	Quantity		 [min]	Comment
Melting butter/ margarine	1/4 lb (100 g)		1:00–1:10	Do not cover
Melting chocolate	1/4 lb (100 g)		3:00–3:30	Do not cover, stir halfway through melting
Dissolving gelatin	1 packet + 5 tbsp water		0:10–0:30	Do not cover, stir halfway through dissolving
Preparing flan topping/fruit glaze	1 packet + 1 cup (250 ml) liquid		4:00–5:00	Do not cover, stir halfway through heating
Yeast dough	Starter made with 1/2 cup (100 g) flour		3:00–5:00	Cover and leave to proof
Chocolate marshmallows	0.7 oz (20 g)		0:10–0:20	Place on a plate, do not cover
Salad dressings	1/2 cup (125 ml)		1:00–2:00	Heat uncovered at low power to bring out flavor
Tempering citrus fruits	1/3 lb (150 g)		1:00–2:00	Place on a plate, do not cover
Bacon	1/4 lb (100 g)		2:00–3:00	Place on paper towel, do not cover
Softening ice cream	1 lb (500 g)		1:00–3:00	Place inside oven, uncovered
Skinning tomatoes	3 tomatoes		6:00–7:00	Cut a cross into the top of each tomato, cover, and heat in a little water. The skins will slip off easily. The tomatoes can get very hot.
Making strawberry jam	1 lb (300 g) strawberries, 1½ cups (300 g) gelling sugar		7:00–9:00	Mix the fruit and sugar in a deep bowl, cover and cook.

 microwave power level,  cooking duration

### Cooking

It is essential that the information in “IMPORTANT SAFETY INSTRUCTIONS – Correct use” is observed.

 Risk of infection due to insufficient cooking

Highly perishable foods – e.g., fish – must be cooked thoroughly. Otherwise, they can pose a health risk.

It is essential to cook highly perishable foods for a sufficient length of time.

 Danger of burning due to hot surfaces.

The microwave oven gets hot during operation. There is a risk of burning yourself on the hot oven compartment, dishware, or food. Spots of condensation may form on the bottom of the dishware. Wear oven gloves when reaching into the hot oven compartment and when removing the dishware.

Food with a thick skin or peel, such as tomatoes, sausages, potatoes, and eggplant can burst when heated or cooked.

Pierce or score the skin of these foods several times to allow steam to escape.

Eggs heated in their shell can burst, even after they have been removed from the oven.

Eggs can only be cooked in their shells in a specially designed egg-boiling device. Do not reheat hard-boiled eggs in the microwave oven.

If you cook eggs without their shells, there is a risk of the yolks exploding due to the resulting pressure.

Prick the yolk several times before cooking to avoid this.

### Tips for cooking

- Only use dishware that is microwave safe.
- Always use a cover.
- The time required depends on the nature of the food, its initial temperature, and the amount to be cooked. For example, food taken straight from the refrigerator takes longer to cook than food which has been kept at room temperature. Take note of the standing times.
- Fresh vegetables contain more water than vegetables which have been stored, and usually cook more quickly. Add 3–4 tbsp of water to vegetables which have been stored.
- Turn, separate, or stir the food several times. Stir the food from the outside toward the middle, as food heats up more quickly at the edges.

# Additional applications

---

- The purpose of the standing time is to allow the food to develop a more even temperature.
- After cooking, allow the food to stand at room temperature for a few minutes to enable the heat to spread more evenly throughout the food.
- If possible, use the automatic programs for cooking.
- Select microwave power level  $\approx 7$  (900 W) to start cooking and then continue cooking at power level  $\approx 4$  (450 W).
- When cooking foods that swell, such as rice pudding or semolina, start with microwave power level  $\approx 7$  (900 W) and then switch to power level  $\approx 2$  (150 W).

## Canning

 Risk of infection from bacteria.

The spores of the botulinum bacterium are not sufficiently killed by canning pulses and meat only once. Toxins may form which can lead to serious poisoning. These spores are only destroyed by canning the food again.

After they have cooled down, **always** reheat pulses and meat a second time within 2 days.

If unsuitable materials are used, there is a risk of generating sparks and damaging the microwave oven as a result.

Use microwave-safe canning jars and seal them with clear adhesive tape or clips suitable for microwave use.

Do not use metal clips, jars with screw-top lids, or cans, as these will generate sparks.

Always observe USDA/CFIA food safety guidelines.

### Preparing fruit and vegetables

The instructions are for a maximum of 4 jars with a capacity of 0.5 L each.

Only use jars that are specifically designed for canning (microwave-safe canning jars with glass lids, sealed with clear adhesive tape).

- Only use undamaged jars.
- Rinse the jars with hot water before canning and fill them up to a maximum of 3/4" (2 cm) below the rim.
- After filling the jars, clean the outside of the rims with a clean cloth and hot water.
- Seal the jars with clear adhesive tape. Do not use metal clips, jars with screw-top lids, or cans, as these will generate sparks.
- Place the jars on the Lazy Susan.

### Canning fruit and vegetables

- Select microwave power level  $\approx 7$  (900 W).
- Wait until bubbles rise evenly in the jars. This takes about 3 minutes per jar. With 4 jars, therefore, it takes 12 minutes.

This is sufficient time for canning fruit and cucumbers.

- When canning other vegetables, reduce the microwave power level to microwave power level  $\approx 4$  (450 W) as soon as bubbles become visible in the jars.

- Continue cooking at microwave power level  $\approx 4$  (450 W) for approx. 15 minutes if canning carrots and for approx. 25 minutes if canning peas.

### Removing the jars after canning

 Danger of injury caused by hot surfaces

The jars will be very hot after canning.

Use oven gloves when removing the jars from the oven.

- Take the jars out of the oven.
- Cover the jars with a towel and leave to stand for approx. 24 hours in a draft-free area.
- After they have cooled down, **always** reheat pulses and meat a second time within 2 days.
- Remove the clips or the adhesive tape and then make sure that all jars are sealed properly.

Either boil open jars again or store them in a cool place and consume the canned fruit or vegetables immediately.

- Check the jars during storage. If jars have opened during storage or if the screw cap is bulging and does not make a popping noise when opened, destroy the contents.

## Cleaning and care

 Danger of injury caused by hot surfaces

The microwave oven gets hot during operation. There is a risk of burning yourself on the hot oven compartment or accessories.

Allow the oven compartment and accessories to cool before manual cleaning.

 Risk of injury due to electric shock

The steam from a steam cleaner could reach live electrical components and cause a short circuit.

Never use a steam cleaner for cleaning.

 Fire hazard due to excessive soiling

Under certain circumstances heavy soiling can catch fire, damaging the the microwave oven.

Clean the oven compartment and inside of the door as soon as they have cooled. Waiting too long to clean the oven will make it much more difficult to clean.

All surfaces could become discolored or damaged if unsuitable cleaning agents are used. The front of the microwave oven is particularly susceptible to damage from oven cleaners.

All surfaces are susceptible to scratching. Scratches on glass can lead to breakage in some circumstances.

Remove all cleaning agent residues immediately.

Operating a damaged microwave oven can result in microwave leakage and present a hazard to the user.

Check the door for damage. If any damage is seen, the microwave oven should **not** be used again until it has been repaired by a service technician. Contact Miele.

### Unsuitable cleaning agents

To avoid damaging the surfaces of your appliance, do not use:

- Cleaning agents containing soda, ammonia, acids, or chlorides
- Cleaning agents containing descaling agents on the front
- Abrasive cleaning agents (e.g., powder cleaners and cream cleaners)
- Solvent-based cleaning agents
- Stainless-steel cleaners
- Dishwasher cleaning agents
- Oven cleaners
- Glass cleaners



- Cleaning agents for ceramic-glass cooktops
- Hard, abrasive brushes or sponges (e.g., pot scourers, brushes, or sponges which have been previously used with abrasive cleaning agents)
- Eraser sponges
- Sharp metal scrapers
- Steel wool
- Spot cleaning with mechanical cleaning agents
- Stainless-steel spiral pads

If soiling is allowed to sit for any length of time, it may become impossible to remove. If the appliance is used frequently without being cleaned, it may become very difficult to clean. It is therefore best to remove any soiling immediately.

### Removing soiling

Moisture inside the microwave oven can cause damage.

Do not use too much water on the cloth or sponge and do not let water or any other liquid find its way into any internal oven openings.

- Remove soiling immediately with warm water, liquid dish soap, and a clean sponge or a clean, damp microfiber cloth.
- Remove all cleaning agent residues thoroughly with clean water.
- After cleaning, wipe the surfaces dry using a soft cloth.
- For heavier soiling, heat a glass of water inside the oven compartment for 2–3 minutes until the water begins to boil. The steam will collect on the oven compartment walls and soften the soiling. You will then be able to remove the soiling (using a little dish detergent if necessary).
- To neutralize odors in the oven compartment, put a container of water with some lemon juice inside the microwave oven and heat for a few minutes.

## Cleaning and care

### Cleaning the oven compartment

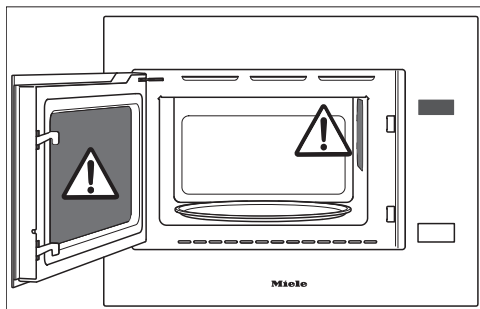

There is a cover protecting the microwave outlet on the right-hand side of the oven compartment and a layer of film protecting the inside of the door, both of which are susceptible to damage.

**Never** remove the cover from the microwave outlet and **never** remove the film from the inside of the door.

Do not use the abrasive side of the dishwashing sponge to clean the cover or inside of the door.

- Wash the turntable in the dishwasher or by hand with a weak solution of dish detergent.

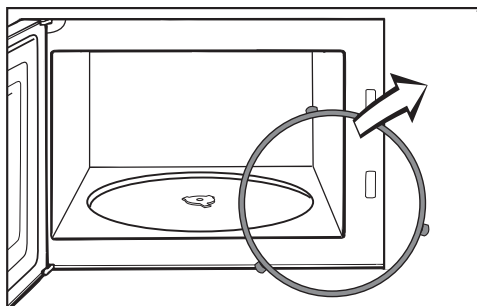

- Remove the roller ring on which the turntable normally rotates.
- Clean the roller ring and the floor of the oven. Otherwise the turntable will not rotate smoothly.
- Clean the contact surfaces between the turntable and the roller ring.
- Put the roller ring back inside and place the turntable on top.

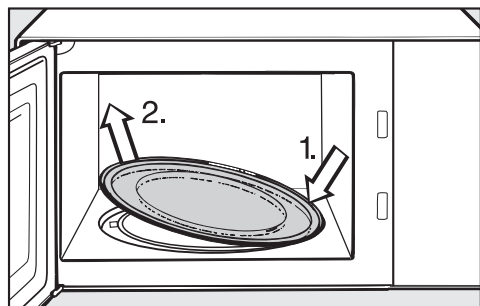

Do not turn the turntable manually, as this could damage the drive motor.

- To remove the turntable, press down on one side (1.) and lift it up by the other (2.).

## Frequently asked questions



Many malfunctions and faults that can occur in daily operation can be easily remedied. You can save time and money in many cases, as you do not need to contact Miele Customer Service.

Information to help you rectify faults yourself can be found at [www.miele.com/service](http://www.miele.com/service).

The following tables are designed to help you to find the cause of a malfunction or a fault and to resolve it.

Problem	Possible cause and solution
<b>You cannot start a cooking process.</b>	The door is still open. ■ Check whether the door is closed properly.
	The <i>door</i> message appears on the display. There may not be any food inside the oven, given that you have not opened the door for a long time (approx. 20 minutes). ■ Open the door and, if necessary, place the food in the oven. ■ Close the door and then select the start  sensor control.
	The system lock is activated. The <i>lock</i> key symbol appears on the display. ■ You can deactivate the system lock by touching the <i>OK</i> sensor control for at least 6 seconds.
	There is no power running to the microwave oven. ■ Check that the electrical plug of the microwave oven is correctly inserted in the outlet. ■ Check if the breaker has tripped. If it has, contact a qualified electrician or Miele Customer Service.
<b>The display is dark.</b>	It is between 11:00 pm and 5:00 am and night dimming is activated. As a result, the display remains dark when the microwave is switched off. ■ As soon as you switch on the microwave oven, the main menu will appear. If you want the time of day to be displayed constantly, select the <i>P 5   5 lock</i> setting (see "Settings").
	There is no power running to the microwave oven. ■ Check that the electrical plug of the microwave oven is correctly inserted in the outlet. ■ Check if the breaker has tripped. If it has, contact a qualified electrician or Miele Customer Service.

## Frequently asked questions

Problem	Possible cause and solution
<b>door appears on the display.</b>	<p>This prompt reminds you that the microwave oven must not be used without any food inside it. There may not be any food inside the microwave oven yet, given that you have not opened the door for a long time (approx. 20 minutes).</p> <ul style="list-style-type: none"> <li>■ Make sure that some food has actually been placed inside the oven.</li> <li>■ Confirm the prompt with <i>OK</i> or by opening and closing the door and selecting the <i>Start</i> sensor control.</li> </ul>
<b>The  key symbol appears on the display.</b>	<p>The system lock is activated.</p> <ul style="list-style-type: none"> <li>■ You can deactivate the system lock by touching the <i>OK</i> sensor control for at least 6 seconds.</li> </ul>
<b>The  symbol and the time of day display both flash.</b>	<p>There has been a power failure.</p> <ul style="list-style-type: none"> <li>■ Reset the time of day.</li> <li>■ If a cooking process was interrupted, restart it from the beginning.</li> </ul>
<b>The turntable is very jerky.</b>	<p>The turntable, roller ring, or floor of the oven may be dirty.</p> <ul style="list-style-type: none"> <li>■ Clean the turntable, the roller ring, and the floor of the oven.</li> <li>■ Clean the contact surfaces between the turntable and the roller ring.</li> <li>■ Put the roller ring back inside and place the turntable on top.</li> </ul>
<b>A noise is heard after the cooking process is complete.</b>	<p>After the cooking process the cooling fan will continue to run for a while after a program is complete to prevent moisture from building up in the oven, on the control panel or surrounding cabinetry. The cooling fan will turn off automatically.</p>
<b>An abnormal sound can be heard during a cooking process.</b>	<p>A metal dish has been used during a cooking process.</p> <ul style="list-style-type: none"> <li>■ Check if the metal dishes you have been using generate sparks (see “Microwave operation – Suitable dishware”).</li> </ul>
	<p>The food was covered with aluminum foil during a cooking process.</p> <ul style="list-style-type: none"> <li>■ Remove the foil, if applicable.</li> </ul>

## Frequently asked questions

Problem	Possible cause and solution
<p><b>The microwave oven has switched itself off.</b></p>	<p>There is insufficient air circulation.</p> <ul style="list-style-type: none"> <li>■ Check whether the vents are blocked. Remove the obstructions, if applicable.</li> </ul>
	<p>For safety reasons, the microwave oven is designed to switch off if it overheats.</p> <ul style="list-style-type: none"> <li>■ Resume the cooking process once the oven has cooled down.</li> </ul>
	<p>The microwave oven keeps switching itself off.</p> <ul style="list-style-type: none"> <li>■ Contact Miele Customer Service.</li> </ul>
<p><b>The food has not been defrosted, heated, or cooked sufficiently on completion of the cooking process.</b></p>	<p>Check whether the cooking process was interrupted without restarting it.</p> <ul style="list-style-type: none"> <li>■ Restart the cooking process to ensure the food gets defrosted, heated, or cooked properly.</li> </ul>
	<p>The cooking duration you set was too short.</p> <ul style="list-style-type: none"> <li>■ Check that the correct duration is selected for the microwave power level. The lower the microwave power level, the longer the duration required.</li> </ul>
<p><b>Food has cooled down too quickly after being reheated or cooked using microwave power.</b></p>	<p>In the microwave, food begins to cook from the outside first, the inside of the food relying on the slower conduction of heat. If food is cooked at a high microwave power level, it is possible that the heat may not have reached the center of the food, so it is hot on the outside but cold in the centre. During the standing time, the heat is transferred to the center of the food.</p> <ul style="list-style-type: none"> <li>■ When reheating food with different densities, such as with menu cooking, it is sensible to start with a low microwave power level and select a longer reheating duration.</li> </ul>
<p><b>The oven interior lighting does not switch on.</b></p>	<p>The lamp is faulty. You can operate the appliance as usual, but the lamp has blown.</p> <ul style="list-style-type: none"> <li>■ Contact Miele Customer Service.</li> </ul>

# Customer Service

---

Information to help you rectify faults yourself and about Miele spare parts can be found at [www.miele.com/service](http://www.miele.com/service).

## Contact in the event of a fault

In the event of a fault which you cannot remedy yourself, please contact your Miele dealer or Miele Customer Service.

You can book a Miele Service Call online at [www.miele.com/service](http://www.miele.com/service).

Contact information for Miele Customer Service can be found at the end of this document.

Please quote the model identifier and serial number of your appliance (SN) when contacting Miele Customer Service. Both pieces of information can be found on the data plate.

This information is given on the data plate, which is visible on the front frame of the oven when the door is fully open.

## Appliance warranty and product registration

You can register your product and/or view the manufacturer's warranty terms and conditions for Miele appliances and vacuum cleaners at [www.mieleusa.com](http://www.mieleusa.com).

**Please have the model and serial number  
of your appliance available when  
contacting Customer Service.**

---

## **U.S.A.**

**Miele, Inc.**

### **National Headquarters**

9 Independence Way  
Princeton, NJ 08540  
[www.mieleusa.com](http://www.mieleusa.com)

### **Customer Support**

Phone: 888-99-MIELE (64353)  
[info@mieleusa.com](mailto:info@mieleusa.com)

### **International Headquarters**

Miele & Cie. KG  
Carl-Miele-Straße 29  
33332 Gütersloh  
Germany

## **Canada**

**Importer  
Miele Limited**

### **Headquarters and Miele Centre**

161 Four Valley Drive  
Vaughan, ON L4K 4V8  
[www.miele.ca](http://www.miele.ca)

### **Customer Care Centre**

Phone: 1-800-565-6435  
905-532-2272  
[customercare@miele.ca](mailto:customercare@miele.ca)

M 2241 SC

en-US, CA

M.-Nr. 12 003 570 / 02