

## Operating and Installation Instructions Ventilation Hood



To prevent accidents and damage to the appliance, you **must** read these instructions before installing the appliance and using it for the first time.

# Contents

---

<b>IMPORTANT SAFETY INSTRUCTIONS</b> .....	4
<b>Caring for the environment</b> .....	13
<b>Guide to the ventilation hood</b> .....	14
<b>Description of functions</b> .....	16
<b>Before using for the first time</b> .....	17
Selecting extraction mode or recirculation mode.....	17
Setting up Miele@home .....	17
Connecting via the app .....	18
Connecting via WPS .....	19
Signing out of WiFi (reset to factory settings) .....	20
Setting up Con@ctivity .....	21
Con@ctivity via the home WiFi network (Con@ctivity 3.0) .....	22
Con@ctivity via a direct WiFi connection (Con@ctivity 3.0) .....	22
Reattempting the connection .....	23
Con@ctivity with direct wireless connection (Con@ctivity 2.0) .....	23
<b>Operation (Automatic mode)</b> .....	27
Cooking with Con@ctivity (Automatic mode) .....	27
Cooking process .....	27
Temporarily exiting Automatic mode .....	28
Resuming Automatic mode .....	28
<b>Operation (Manual mode)</b> .....	29
Cooking without Con@ctivity (Manual mode) .....	29
Turning on the blower .....	29
Selecting the power level .....	29
Selecting the delayed shutdown time .....	29
Turning off the blower .....	29
Dimming/switching the overhead lighting on/off .....	29
Power management .....	30
Safety shut-off .....	30
<b>Operation (Automatic and Manual modes)</b> .....	31
Filter saturation indicator .....	31
Adjusting the grease filter filter saturation indicator .....	31
Adjusting or deactivating the filter saturation indicator for the charcoal filter .....	32
Checking the filter saturation indicator .....	32
<b>Energy-saving tips</b> .....	33

---

<b>Cleaning and care</b> .....	34
Stainless steel housing.....	34
Important information for appliances with stainless steel surfaces .....	34
Important information for appliances with lacquered housing.....	34
Grease filters .....	35
Replacing the grease filter.....	36
OdorFree Charcoal Filter .....	37
Resetting the filter saturation indicator for the charcoal filters.....	37
Disposing of charcoal filters .....	37
<b>Installation</b> .....	38
Before installation.....	38
Removing the protective film.....	38
Installation materials.....	38
Appliance dimensions .....	40
Distance between cooktop and ventilation hood (S).....	41
Installation recommendations .....	42
Drilling diagram for wall mounting.....	42
Plywood backing .....	43
To install a plywood backing .....	43
Air venting .....	44
Non-return flap .....	44
Condensate .....	45
Reducing Collar .....	45
Electrical connection .....	46
<b>Customer Service</b> .....	47
Contact in the event of a fault.....	47
Location of the data plate .....	47
Appliance warranty and product registration .....	47
<b>Technical data</b> .....	48
Optional accessories for recirculation mode.....	48

# IMPORTANT SAFETY INSTRUCTIONS

---

## READ AND SAVE THESE INSTRUCTIONS

This appliance complies with current safety requirements. Improper use of the appliance can lead to personal injury and material damage.

Read all instructions before installing or using the appliance for the first time. Only use the appliance for its intended purpose.

Keep these operating instructions in a safe place and pass them on to any future user.

### **Appropriate use**

- ▶ **CAUTION:** For General Ventilating Use Only. Do Not Use To Exhaust Hazardous Or Explosive Materials And Vapors.
- ▶ This appliance is intended for residential use only. Use only as described in these operating instructions.
- ▶ This ventilation hood is not intended for outdoor use.
- ▶ It must only be used to extract and clean vapors produced during cooking. Any other use occurs at the owner's own risk.
- ▶ Where a recirculation ventilation hood is installed above a gas cooktop, please check that all local codes are observed to insure an adequate supply of fresh air.
- ▶ This appliance is suitable for installation above gas or electric cooking surfaces.
- ▶ Persons who lack physical, sensory or mental abilities, or experience with the appliance should not use it without supervision or instruction by a responsible person.

# IMPORTANT SAFETY INSTRUCTIONS

---

## Safety with children

- ▶ Children must be kept away from the ventilation hood unless they are constantly supervised.
- ▶ Children must not be allowed to clean or service the hood.
- ▶ Please supervise children in the vicinity of the hood and do not let them play with it.
- ▶ The LED ClearView lighting is very intense.  
Avoid looking directly into the light for prolonged periods of time.
- ▶ Danger of suffocation. While playing, children may become entangled in packaging material (such as plastic wrapping) or pull it over their head, presenting the risk of suffocation. Keep packaging material away from children.

## Technical safety

- ▶ **WARNING: TO REDUCE THE RISK OF FIRE, ELECTRIC SHOCK, OR INJURY TO PERSONS, OBSERVE THE FOLLOWING:**
  - Use this appliance only in the manner intended by the manufacturer. If you have questions, contact Miele.
  - Before servicing or cleaning the appliance, switch power off at the service panel and lock the service disconnecting means to prevent power from being switched on accidentally. If the service disconnecting means cannot be locked, securely fasten a prominent warning device, such as a tag, to the service panel.
- ▶ Unauthorized installation, maintenance, and repairs can cause considerable danger for the user. Installation, maintenance, and repairs must only be carried out by a Miele authorized technician.
- ▶ A damaged ventilation hood can be dangerous. Always check for visible signs of damage. Never use a damaged ventilation hood.

## IMPORTANT SAFETY INSTRUCTIONS

---

- ▶ Be certain your appliance is properly installed and grounded by a qualified technician. To guarantee the electrical safety of this appliance, continuity must exist between the appliance and an effective grounding system. It is imperative that this basic safety requirement be met. If there is any doubt, have the electrical system of the house checked by a qualified electrician.
- ▶ Temporary or permanent operation on an autonomous power supply system or a power supply system that is not synchronized with the grid power supply (e.g., island networks, back-up systems) is possible. A prerequisite for operation is that the power supply system complies with national and local codes.  
The function and operation of the protective measures provided in the domestic electrical installation and in this Miele product must also be maintained in isolated operation or in operation that is not synchronized with the grid power supply, or these measures must be replaced by equivalent measures in the installation.
- ▶ To avoid damaging the ventilation hood, make sure that the connection data (voltage and frequency) on the data plate correspond to the building's power supply before connecting the appliance.  
If in doubt, consult a qualified electrician.
- ▶ Do not use a power bar or extension cord to connect the ventilation hood to electricity. These are a fire hazard and do not guarantee the required level of appliance safety.
- ▶ To ensure safe operation, only use the ventilation hood after it has been properly installed.
- ▶ This ventilation hood may not be used in non-stationary locations (e.g. on a ship).
- ▶ Adequate ventilation must be provided when the hood is operated simultaneously with devices that burn gas or other fuels.

# IMPORTANT SAFETY INSTRUCTIONS

---

▶ Only open the housing as described in the enclosed “Installation diagram” and in the “Cleaning and care” section of this manual. Under no circumstances should any other parts of the housing be opened.

Tampering with electrical connections or components and mechanical parts is highly dangerous to the user and can cause operation faults.

▶ If the power cord is damaged, it must only be replaced by a qualified service technician.

▶ During installation, maintenance, and repair work, the ventilation hood must be disconnected from the electrical supply. It is only completely isolated from the electricity supply if one of the following applies:

- The circuit breakers on the electrical service panel are tripped.
- The screw-type fuses on the electrical service panel have been removed.
- The power cord (if present) has been unplugged from the socket (pull the plug not the cord).

## **Correct use**

▶ **WARNING: TO REDUCE THE RISK OF A COOKTOP GREASE FIRE:**

- a) Never leave surface units unattended at high settings. Boilovers cause smoking and greasy spillovers may ignite. Heat oils slowly on low or medium settings.
- b) Always turn the hood on when cooking at a high heat.
- c) Clean the ventilation hood frequently. Grease should not be allowed to accumulate on the fan or filter.
- d) Use the proper pan size. Always use cookware appropriate for the size of the cooking area.

# IMPORTANT SAFETY INSTRUCTIONS

---

► Open flames are a fire hazard.

The use of an open flame under the ventilation hood is not permitted. To avoid the danger of fire, do not flambé or grill over an open flame. When switched on, the ventilation hood could draw flames into the filter. Fat deposits could ignite, presenting a fire hazard.

► **WARNING: TO REDUCE THE RISK OF INJURY TO PERSONS IN THE EVENT OF A COOKTOP GREASE FIRE, OBSERVE THE FOLLOWING\*:**

- a) **SMOTHER FLAMES** with a close fitting lid, cookie sheet, or metal tray then turn off the burner. **BE CAREFUL TO PREVENT BURNS.** If the flames do not go out immediately, **EVACUATE AND CALL THE FIRE DEPARTMENT.**
- b) **NEVER PICK UP A FLAMING PAN** - You may be burned.
- c) **DO NOT USE WATER**, including wet dishcloths or towels - a violent steam explosion will result.
- d) Use a fire extinguisher **ONLY** if:
  - 1) You have a class ABC extinguisher, and you know how to operate it.
  - 2) The fire is small and contained in the area where it started.
  - 3) The fire department is being called.
  - 4) You can fight the fire with your back to an exit.

\*Based on “Kitchen Fire Safety Tips” published by NFPA.

► The ventilation hood may become damaged if exposed to excessive heat from a gas cooktop.

- When using the ventilation hood over a gas cooktop, ensure that any burners in use are always covered by cookware. Turn burners off when removing the cookware, even if doing so for just a short time.
- Select cookware that is suitable for the size of the burner.
- Adjust the flame so that it never extends up the sides of the cookware.
- Avoid overheating the cookware (e.g., when cooking with a wok).



## IMPORTANT SAFETY INSTRUCTIONS

---

▶ Always turn the ventilation hood on whenever a burner is in use to prevent damage from condensation.

▶ Overheated oil and fat can ignite, causing fire damage to the ventilation hood.

Do not leave cookware, pans, and deep-fat fryers unattended when cooking with oil or fat. Similarly, never leave an open flame unattended when grilling.

▶ Fat and debris deposits impair the proper functioning of the ventilation hood.

To ensure that cooking vapors are properly cleaned, never use the ventilation hood without the grease filters in place.

▶ Please note that the heat rising from the stovetop during cooking can cause the ventilation hood to become very hot.

Do not touch the housing or the grease filters until the ventilation hood has cooled down.

# IMPORTANT SAFETY INSTRUCTIONS

---

## Proper installation

- ▶ **WARNING: TO REDUCE THE RISK OF FIRE, ELECTRIC SHOCK, OR INJURY TO PERSONS, OBSERVE THE FOLLOWING:**
  - a) Installation work and electrical wiring must be done by qualified person(s) in accordance with all applicable codes and standards, including fire-rated construction.
  - b) Sufficient air is needed for combustion and exhausting of gases through the flue (chimney of fuel burning equipment to prevent back drafting. Follow the heating equipment manufacturer's guideline and safety standards such as those published by the National Fire Protection Association (NFPA) and the American Society for Heating, Refrigeration and Air Conditioning Engineers (ASHRAE), and the local code authorities.
  - c) When cutting or drilling into the wall or ceiling, do not damage electrical wiring and other hidden utilities.
  - d) Ducted hoods must always be vented to the outdoors.
  - e) Do not use this hood with any solid-state speed control device.
- ▶ To determine whether a ventilation hood may be operated above your cooking appliance, please refer to the information provided by the appliance's manufacturer.
- ▶ Safety regulations prohibit the installation of a ventilation hood over solid fuel stoves.
- ▶ An insufficient safety distance between the cooktop and the ventilation hood can result in damage to the ventilation hood. The minimum safety distances between the top of the cooktop and the bottom of the ventilation hood given in the "Installation" section of this manual must be observed, unless the cooktop manufacturer states that a greater safety distance is required. If more than one cooking appliance is installed beneath the ventilation hood, and they have different minimum safety distances to the ventilation hood, select the greater distance.

## IMPORTANT SAFETY INSTRUCTIONS

---

- ▶ The information provided in “Installation” must be observed when installing the ventilation hood.
- ▶ Components can have sharp edges which may cause injury. Wear gloves to protect your hands.
- ▶ When installing the exhaust duct, only use pipes or tubes made of non-flammable material. These can be obtained from your Miele dealer or from Miele Technical Service. Always observe local building code requirements when selecting duct material.
- ▶ Exhaust air should not be vented into a chimney or vent flue which is otherwise in use and should not be channeled into ducting which ventilates rooms with fuel-burning installations.
- ▶ If exhaust air is to be extracted into a chimney or ventilation duct no longer used for other purposes, seek professional advice.
- ▶ **WARNING: TO REDUCE THE RISK OF FIRE USE ONLY METAL DUCTWORK.**

### **Cleaning and maintenance**

- ▶ There is a risk of fire if cleaning is not completed according to the instructions in this manual.
- ▶ Never use a steam cleaner to clean the ventilation hood. The steam can reach the electrical components and cause a short circuit.

### **Accessories and parts**

- ▶ Use only genuine original Miele parts. If parts or accessories from other manufacturers are used, the warranty may become void.
- ▶ Defective components should be replaced by Miele original parts only. Only with these parts can safety of the appliance be assured as intended by the manufacturer.

## **IMPORTANT SAFETY INSTRUCTIONS**

---

▶ Miele will guarantee to supply functional parts for a minimum of 10 years and up to 15 years following the discontinuation of your ventilation unit.

### **FCC Declaration of Conformity**

▶ These devices comply with FCC Rules Part 15. This equipment has been tested and found to be in compliance with the limits for a Class B digital device, pursuant to Part 15 of the FCC Rules of Operation and is subject to the following conditions:  
These devices may not cause harmful interference.  
These devices must accept any interference received, including interference that may cause undesired operation.

### **FCC Radiation Exposure Statement**

▶ This equipment complies with FCC radiation exposure limits set forth for an uncontrolled environment. This equipment should be installed and operated with minimum distance 8" (20 cm) between the radiator and your body.

### **Industry Canada Statement**

▶ This digital apparatus does not exceed the Class B limits for Radio Noise Emissions from digital apparatus set out in the Radio Interference Regulations of the Canadian Department of Communications.

Complies with Canadian ICES-003 Class B specifications.

### Disposal of the packing material

The cardboard box and packing materials protect the appliance during shipping. They have been designed to be biodegradable and recyclable.

Ensure that any plastic wrappings, bags, etc. are disposed of safely and kept out of the reach of children.  
Danger of suffocation!

### Disposal of your old appliance

Electrical and electronic appliances contain valuable materials. They also contain certain substances, compounds and components which were essential for the proper functioning and safe use of the equipment. Handling these materials improperly by disposing of them in your household waste can be harmful to your health and the environment. Therefore, please do not dispose of your old appliance with regular household waste and follow local regulations on proper disposal.



Consult with local authorities, dealers or Miele in order to dispose of and recycle electrical and electronic appliances. Miele assumes no responsibility for deleting any personal data left on the appliance being disposed. Please ensure that your old appliance is kept away from children until removal. Observe safety requirements for appliances that may tip over or pose an entrapment hazard.

# Guide to the ventilation hood

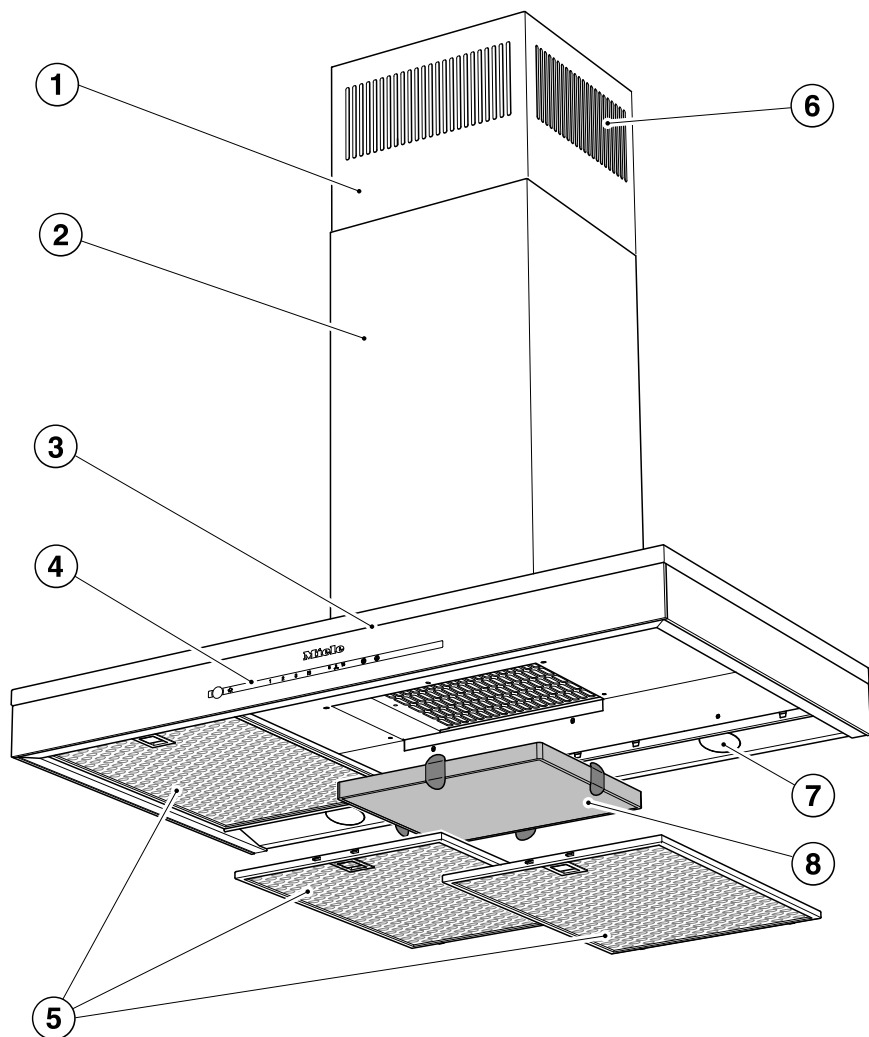

- ① Telescopic extension piece
- ② Duct cover
- ③ Canopy
- ④ Controls
- ⑤ Grease filter
- ⑥ Recirculation vents  
Only for recirculation mode
- ⑦ Overhead lighting
- ⑧ Charcoal filters  
Optional accessories for recirculation mode
- ⑨ Sensor control for turning the blower on and off
- ⑩ Sensor control for switching the lighting on and off and for dimming the lighting
- ⑪ Sensor controls for setting the blower power
- ⑫ Sensor control for the delayed shutdown function
- ⑬ Sensor control for the grease filter saturation indicator
- ⑭ Sensor control for the charcoal filter saturation indicator

# Description of functions

---

The following functions are available on your ventilation hood, depending on the model:

## Extraction mode



dafr0494a

The air is drawn in and cleaned by the grease filters and directed outside.

## Recirculation mode

The recirculation mode requires a recirculation kit and OdorFree Charcoal Filter (available as optional accessories, see “Technical Data” for more information)



dafr0494b



The air is drawn in and first cleaned by the grease filters and then by an OdorFree Charcoal Filter. The cleaned air is then recirculated back into the kitchen.





## Selecting extraction mode or recirculation mode

The ventilation hood can be operated with either extraction mode or recirculation mode. The power of the blower is adapted to suit the selected mode of operation. The ventilation hood is set up at the factory for recirculation mode. It has to be reset for extraction mode.

To reset it for extraction mode, the filter saturation indicator for the charcoal filter(s) has to be deactivated.

- Switch off the blower and the lighting.
- Touch the delayed shutdown control  and the charcoal filter control  at the same time.

The charcoal filter symbol  and one of the blower power level indicators will flash.

- Touch the **B** control.
- Confirm your choice by touching the charcoal filter control .

All the indicator lights will go out.

Extraction mode has now been set.

If the new setting is not confirmed within 4 minutes, the ventilation hood will revert to the previous setting.

## Setting up Miele@home

Required:

- a WiFi network
- the Miele app
- a Miele user account. You can create a user account via the Miele app.

Your ventilation hood is equipped with an integrated WiFi module. Connect the ventilation hood to your household WiFi network. You will then be able to operate the ventilation hood via the Miele app.

If your Miele cooktop is connected to a home WiFi network, you can control the ventilation hood automatically via the Con@ctivity function.

Before installing the ventilation hood in its final location, ensure that the signal of your WiFi network is strong enough.

Please note that you cannot set up a WiFi connection at the same time as a wireless connection (Con@ctivity 2.0, remote control).

You can connect to the household WiFi network via the Miele app or via WPS.

# Before using for the first time

---

## Miele App

The Miele App is available to download free of charge from the Apple App Store® or from the Google Play Store™.



## Connecting via the app

The Miele app can be used to connect to your network.

- Install the Miele app on your mobile device.

To log in you will need:

1. your WiFi network password
2. your ventilation hood password



The password for your ventilation hood consists of the last 9 digits of the serial number. This can be found on the appliance's data tag.

The data plate is visible once you have removed the grease filter.

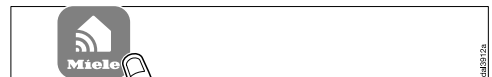

- Start signing the appliance on in the app. Follow the signing in instructions.

If requested to activate WiFi on the ventilation hood, proceed as follows:

# Before using for the first time

- Switch the ventilation hood off.



- Press and hold the **B** control.



- Touch the lighting control  at the same time.



**2** will light up constantly, **3** will flash on and off.

The ventilation hood will be ready for connection in the next 2 minutes.

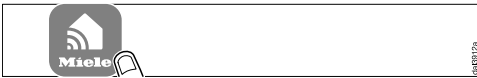

- Follow the instructions in the app.

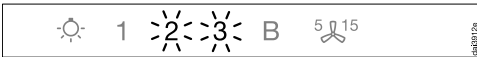

When successfully connected, **2** and **3** will light up constantly.



- Quit connection mode on the ventilation hood by touching the delayed shutdown control .

The ventilation hood can now be operated via the app.

## Connecting via WPS

Your WiFi router must support WPS (WiFi Protected Setup).

- Switch the ventilation hood off.



- Press and hold the **B** control.



- Touch the lighting control  at the same time.



**2** will light up constantly, **3** will flash on and off.

The WiFi connection must be started on the ventilation hood at the same time as on the WiFi router.

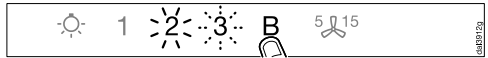

- Press the **B** control on the ventilation hood after a few seconds.

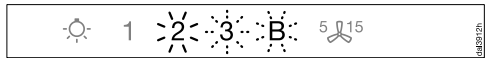

After a short while, **2** will light up constantly, and **3** and **B** will flash on and off.

The ventilation hood is ready for connection in the next two minutes.

## Before using for the first time

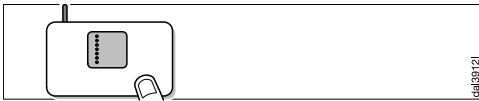

- Start the WiFi connection on your WiFi router.

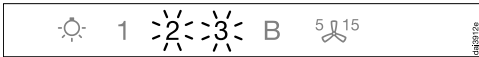

When successfully connected, **2** and **3** will light up constantly.



- Quit connection mode on the ventilation hood by touching the delayed shutdown control **5** **15**.

The ventilation hood can now be operated via the app.

If the connection fails, you have probably not connected WPS to your router quickly enough. Repeat the steps above.

**Tip:** If your WiFi router does not support WPS, please connect via the Miele app.

### Signing out of WiFi (reset to factory settings)

To set up a new WiFi connection, the existing WiFi connection must be disconnected.

- Switch the ventilation hood off.



- Press and hold the **1** control.



- Touch the lighting control  at the same time.

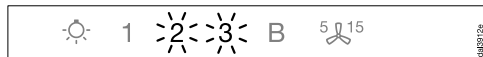

With an existing WiFi connection, **2** and **3** will light up constantly.

The ventilation hood is ready for disconnection during the next two minutes.

# Before using for the first time



- Touch the **1** control.

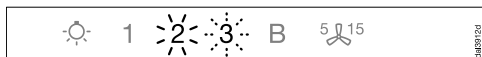

**2** will light up constantly, **3** will flash on and off.

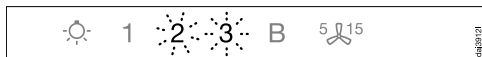

After a few seconds, **2** and **3** will flash on and off. The connection has now been disconnected.



- Quit disconnection mode on the ventilation hood by touching the delayed shutdown control **5**  **15**.

The WiFi connection has now been disconnected. A new connection can now be set up.

## Setting up Con@ctivity

Con@ctivity is the direct communication system between an induction Miele cooktop and a Miele ventilation hood. It enables the ventilation hood to operate automatically depending on the operational state of a Miele cooktop with onset controls.

- When a burner is turned on, the overhead lighting on the hood turns on automatically. After a brief delay, the ventilation hood blower also comes on.
- The ventilation hood selects the power setting automatically during cooking. The power level selected by the ventilation hood depends on the number of cooking zones being used and their power levels.
- After switching the cooktop off, the blower and the overhead lighting will switch off automatically after a specified period of time.

Detailed information about this function can be found under “Operation”.

## Before using for the first time

This ventilation hood can be operated with the Con@ctivity function via a WiFi connection (Con@ctivity 3.0) or via a wireless connection (Con@ctivity 2.0).

### Con@ctivity via the home WiFi network (Con@ctivity 3.0)

Prerequisite:

- Home WiFi network
- WiFi-enabled Miele cooktop

- Connect the ventilation hood and cooktop to your home WiFi network (see “Setting up Miele@home”).

The Con@ctivity function will be activated automatically.

### Con@ctivity via a direct WiFi connection (Con@ctivity 3.0)

Prerequisite:

- WiFi enabled Miele cooktop

If you do not have a home network, you can establish a direct connection between the cooktop and the ventilation hood.

- Switch the ventilation hood off.

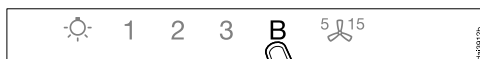

- Press and hold the **B** control.

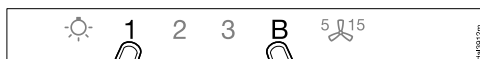

- Touch the **1** control at the same time.

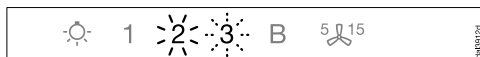

**2** will light up constantly, **3** will flash on and off.

The ventilation hood is ready for connection in the next two minutes.

# Before using for the first time

- Start WiFi connection on the cooktop. For more details, see the cooktop operating instructions.

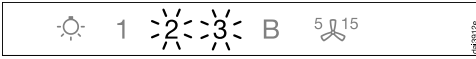

When successfully connected, **2** and **3** will light up constantly.



- Quit connection mode on the ventilation hood by touching the delayed shutdown control **5/15**.

Con@ctivity has now been activated.

With a direct WiFi connection, it is not possible to connect the cooktop and the ventilation hood to a home network. Should this be required at a later date, the WiFi connection between the cooktop and the ventilation hood must be disconnected (see “Signing out of WiFi”).

## Reattempting the connection

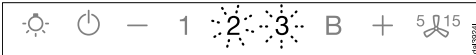

If it is not possible to connect, **2** and **3** flash or the ventilation hood cancels the process.

- Disconnect the connection to the ventilation hood (see “Signing out of WiFi”) and to the cooktop.
- Attempt to make the connection again.

## Con@ctivity with direct wireless connection (Con@ctivity 2.0)

Required:

- Con@ctivity 2.0 enabled Miele induction cooktop

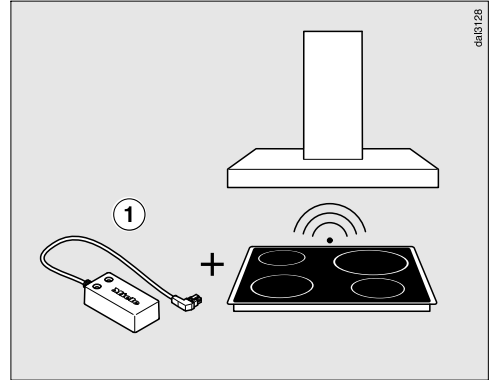

This ventilation hood is supplied with a Con@ctivity 2.0 wireless stick **1**.

The wireless stick can only be used with cooktops that are fitted with a slot for the wireless stick to operate the Con@ctivity function.

- Check the installation instructions for the Con@ctivity 2.0 stick to ensure that it is compatible with your cooktop.

Please note that you cannot set up a WiFi connection at the same time as a wireless connection (Con@ctivity 2.0, remote control).

# Before using for the first time

## Installing the Con@ctivity 2.0 stick

- See the relevant installation instructions provided with the Con@ctivity 2.0 stick.

## Activating the wireless connection

The ventilation hood and the cooktop must be installed and operational.

The wireless connection must be activated on the ventilation hood and the cooktop at the same time. Activation on the ventilation hood is described below.

Activation on the cooktop is described in the relevant operating and installation instructions. Please refer to the operating instructions before starting. Activate the ventilation hood first, then the cooktop.

## Activating the ventilation hood

- The cooktop and ventilation hood must be switched off.



- Touch the delayed shutdown control  $5 \text{ fan } 15$  for approx. 10 seconds until **1** lights up.

- Then touch in turn:



- the **1** control,

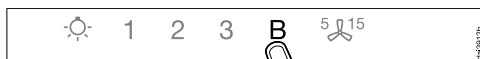

- then the **B** control,



- then the lighting control  $\text{lighting icon}$ .

The ventilation hood is now in signing on/off mode.

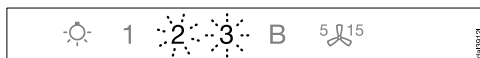

If a wireless connection has not yet been established, **2** and **3** will flash at the same time.

If a wireless connection has already been established, **2** and **3** will light up constantly (Con@ctivity 2.0 is already activated or a remote control is signed on).



# Before using for the first time



- Touch the **B** control to activate Con@ctivity 2.0.

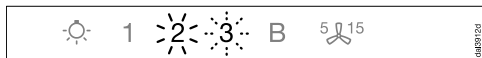

- **2** will light up constantly, **3** will flash on and off.

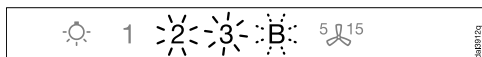

After a few seconds, **2** and **3** will light up constantly, **B** will flash on and off.

The search for a wireless connection will start.

## Activating the cooktop



- **While** the ventilation hood is searching for a signal, start activating the cooktop.  
For more details, see the cooktop operating instructions.
- When the cooktop registers that a connection has been established, exit activation on the cooktop.

## Finishing activation on the ventilation hood

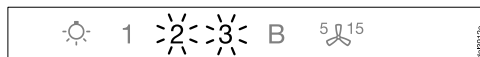

When successfully connected, **B** will go out, and **2** and **3** will light up constantly.



- Confirm activation with the delayed shutdown control **5 15**. All the indicator lights will go out.

The Con@ctivity function is now ready for use.

If you do not confirm within 4 minutes, activation will be canceled.

You only need to carry out the activation procedure once. If the appliances are disconnected from the electricity supply, for example during a loss of power, they will still remain activated.

# Before using for the first time

## Activation failed

If a wireless connection cannot be established despite activation of the Con@ctivity function on the ventilation hood and cooktop, the function must first be deactivated and then reactivated on both appliances.

## Deactivating the wireless connection

- The cooktop and ventilation hood must be switched off.



- Touch the delayed shutdown control  $5 \text{ } 15$  for approx. 10 seconds until **1** lights up.

- Then touch in turn:



- the **1** control,



- then the **B** control,



- then the lighting control  $\odot$ .

The ventilation hood is now in signing on/off mode.

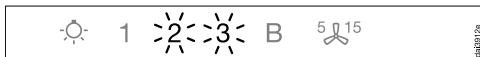

If a wireless connection has already been established, **2** and **3** will light up constantly.



- Touch the **1** control to deactivate Con@ctivity 2.0.

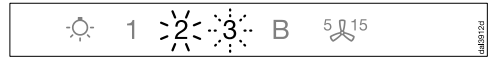

**2** will light up constantly, **3** will flash on and off.

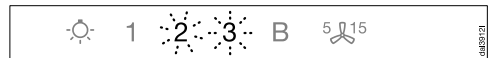

After a few seconds, **2** and **3** will start flashing on and off.

The wireless connection has now been deactivated.

- To deactivate the cooktop, please refer to the corresponding operating instructions.

Please bear in mind that disabling the connection will also disable any remote control function being used. The remote control must then be reactivated.

# Operation (Automatic mode)

When Con@ctivity is active, the ventilation hood always operates in automatic mode (see “Before using for the first time – Setting up Con@ctivity”).

If you wish to operate the ventilation hood manually; see “Operation (Manual mode) – Cooking without Con@ctivity”.

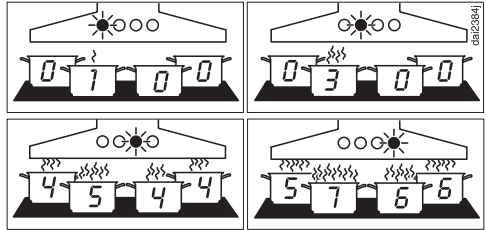

Examples for power levels 1 to B

## Cooking with Con@ctivity (Automatic mode)

- Turn on a burner to the desired power setting.

The overhead lighting will come on.

After a few seconds, the blower will come on, briefly operating at power level 2 before immediately switching to level 1.

The ventilation hood selects the power level automatically during cooking.

This level is determined by the total output of the cooktop, i.e., the number of burners in operation and the power levels selected.

If you select a higher power level on the cooktop or switch on multiple burners, the ventilation hood will switch to a higher blower level.

If you select a lower power level on the cooktop or turn off a burner, the ventilation hood will accordingly switch to a lower blower level.

## Reaction time

Changing the power setting on the cooktop does not lead to an immediate increase or decrease in cooking vapors. For this reason, the hood reacts with a slight delay.

Delays can also result from the fact that the cooktop transmits the information to the hood in intervals.

The reaction time can vary from a few seconds to a couple of minutes.

## Cooking process

- For example, you switch on a burner at the highest power level to heat cookware for frying. After approx. 10 seconds to 4 minutes, you then reduce the power level (60 seconds to 5 minutes for a HiLight cooktop).

The ventilation hood recognizes a cooking process.

The ventilation hood turns itself on and when the cooktop power level has been reduced, the ventilation hood switches to power level 3 and remains at that level for approx. 5 minutes.

After this, the blower level is once again determined by the Con@ctivity function.

You can also manually select a different blower level before then.

# Operation (Automatic mode)

---

## Switching off

- Turn off all burners.

Over the next few minutes, the ventilation hood blower setting will decrease one level at a time until the hood eventually turns off.

This helps to neutralize any lingering vapors and odors in the air.

- From the Booster setting, the blower switches immediately to level 3.
- From level 3, it will switch to level 2 after approx. 1 minute.
- From level 2, it will switch to level 1 after 2 minutes.
- After 2 minutes at level 1, the blower automatically turns off.
- After another 30 seconds, the overhead lighting turns off.

The cooking process is then finished.

## Temporarily exiting Automatic mode

To temporarily exit Automatic mode when cooking:

- Manually select a different blower level; or
- Manually turn the ventilation hood off; or
- Activate the delayed shutdown function  on the ventilation hood. The blower will switch itself off after the selected run-on time, and the lighting will remain on.

The ventilation hood functions are now operated manually (see “Operation (Manual mode)”).

## Resuming Automatic mode

The ventilation hood resumes Automatic mode:

- If the ventilation hood has not been used for a period of approx. 5 minutes after the manual selection of a blower level; or
- If the manually selected blower level once again matches the automatic setting; or
- The ventilation hood blower and the cooktop have been switched off for at least 30 seconds. Automatic mode will resume next time the cooktop is switched on.

You can also operate the ventilation hood manually for a complete cooking process.

- To do so, switch the ventilation hood blower on **before** the cooktop.

If the ventilation hood and the cooktop have been switched off for at least 30 seconds after cooking, Automatic mode will resume next time the cooktop is switched on.

## Cooking without Con@ctivity (Manual mode)

The ventilation hood can be operated manually if:

- The Con@ctivity function is not activated.
- You have temporarily deactivated the Con@ctivity function (see “Operation (Automatic mode) – Temporarily exiting Automatic mode”).

## Turning on the blower

Switch the blower on as soon as you start cooking. This is to ensure that vapors are captured right from the start.

- Touch the On/Off control .

The blower switches on at power level **2**.

## Selecting the power level

Power levels **1** to **3** are available for light to heavy cooking vapors and odors.

For strong vapors and odors that are temporarily produced when cooking, e.g., during searing, select the **B** booster level.

- Select the power level required by tapping a button from **1** to **B**.

## Reducing power down from the Booster setting





If power management is activated (default setting), the blower automatically switches back to level **3** after 5 minutes.

## Selecting the delayed shutdown time

It is advisable to run the blower for a few minutes after cooking has finished. This helps to neutralize any lingering vapors and odors in the air.

It also reduces the risk of residues accumulating in the ventilation hood and any resultant odors.

The delayed shutdown function enables the blower to continue running for a pre-determined time before switching itself off automatically.

- After you have finished cooking, touch the delayed shutdown control .
- Once: blower switches off after 5 minutes (**5**  lights up).
- Twice: blower switches off after 15 minutes ( **15** lights up).
- If you touch the delayed shutdown control  again, the blower will remain switched on ( will go out).

## Turning off the blower

- Press the On/Off control  to turn the blower off.

## Dimming/switching the overhead lighting on/off



The overhead lighting can be switched on and off and dimmed independently of the blower.

- Touch the lighting control  briefly to switch it on or off.

The lighting will switch on at maximum brightness.

# Operation (Manual mode)

---

- With the lighting switched on, press and hold the lighting control . The brightness will gradually dim until you release the control.
- To increase the brightness, press and hold the lighting control  again until the desired level has been reached and then release it.

## Power management

The ventilation hood is equipped with a power management system. Power management helps to save energy. It ensures that the blower power level is reduced automatically and that the lighting is switched off.



- If the booster level is selected, the blower automatically switches to level 3 after 5 minutes.
- If the blower is set to level 3, 2, or 1, it switches back one blower setting after 2 hours and then in 30-minute intervals until the blower eventually switches off.
- The overhead lighting will switch off automatically after 12 hours.

You can deactivate power management.

Keep in mind that this may increase energy consumption.

## Activating/deactivating power management

- Switch off the blower and the lighting.
- Touch the delayed shutdown control  for approx. 10 seconds, until **1** lights up in the power level display.
- Then press in order:

- the lighting control ,
- the **1** control, and then
- the lighting control .

When power management is turned on, the **1** and **B** indicators will be continuously lit.

When it is turned off, the **1** and **B** indicators will flash.

- Touch the **1** control to deactivate power management.

The **1** and **B** indicators will flash.

- Touch the **B** control to activate power management.

The **1** and **B** indicators will be continuously lit.



- Confirm the setting by pressing the delayed shutdown control .

All the indicator lights will go out.

If you do not confirm the new setting within 4 minutes, the ventilation hood will revert to the previous setting.

## Safety shut-off



If power management has been deactivated, the ventilation hood will switch itself off automatically after 12 hours if it has been left on (blower and overhead lighting).

- To switch it back on, press the On/Off  control or the lighting control .

# Operation (Automatic and Manual modes)

## Filter saturation indicator

The ventilation hood registers the length of time it has been operated.



The filter saturation indicators show when the filters need to be cleaned or changed by lighting up the grease filter symbol  or charcoal filter symbol . Additional information on cleaning and changing the filters and resetting the filter saturation indicators can be found under “Cleaning and care”.

## Adjusting the grease filter filter saturation indicator

The filter saturation indicator can be set to suit the customer’s cooking habits.

The factory default setting is a cleaning interval of 30 hours.

- Select a shorter interval of 20 hours if food is fried regularly.
- A shorter cleaning interval is also recommended if the customer only cooks occasionally. This will prevent grease buildup from hardening and making cleaning more difficult.
- Select a longer cleaning interval of 40 or 50 hours if the customer uses very little fat when cooking.

- Switch off the blower and the lighting.
- Touch the delayed shutdown control <sup>5</sup> and the grease filter control  at the same time.

The grease filter symbol  and one of the blower power level indicators will flash.

The indicators **1** to **B** show the current time setting:

<b>1</b> .....	20 hours
<b>2</b> .....	30 hours
<b>3</b> .....	40 hours
<b>B</b> .....	50 hours

- Touch the relevant control to select the duration required.
- Confirm your choice by touching the grease filter control .

All the indicator lights will go out.

If the new setting is not confirmed within 4 minutes, the ventilation hood will revert to the previous setting.

# Operation (Automatic and Manual modes)



## Adjusting or deactivating the filter saturation indicator for the charcoal filter

The charcoal filter is needed for recirculation mode.

The filter saturation indicator can be set to suit the customer's cooking habits.

It has to be deactivated for vented mode.

The factory default setting is an interval of 180 hours.

- Switch off the blower and the lighting.
- Touch the delayed shutdown control  and the charcoal filter control  at the same time.

The charcoal filter symbol  and one of the blower power level indicators will flash.

The indicators **1** to **B** show the current time setting:

- 1**..... 120 hours
- 2**..... 180 hours
- 3**..... 240 hours
- B**..... Deactivated



- Touch the relevant control to select the duration required.
- Confirm your choice by touching the charcoal filter control .

All the indicator lights will go out.

If the new setting is not confirmed within 4 minutes, the ventilation hood will revert to the previous setting.

## Checking the filter saturation indicator

Before the set operating time has run out, you can check what percentage of the time has elapsed.

- Press the On/Off control  to turn the blower on.
- Press and hold the grease filter control  or the charcoal filter control .

One or more of the power level indicators will flash.

The number of flashing indicators shows the elapsed operating time as a percentage.

- 1** ..... 25 %
- 1 and 2** ..... 50 %
- 1 to 3** ..... 75 %
- 1 to B** ..... 100 %

The elapsed operating time remains stored in the memory when the ventilation hood is turned off or in the event of an interruption to the power supply.



This hood operates in a very efficient and energy-saving manner. The following will help you to save even more energy when using it:

- Ensure that there is sufficient ventilation in the kitchen when cooking. If there is insufficient air flow during extraction mode, the hood cannot operate efficiently, causing increased operating noise levels.
- Always cook with the lowest possible setting. This produces fewer cooking vapors so that you can use a lower hood power level and therefore benefit from reduced energy consumption.
- Clean or change the filters at regular intervals. Heavily soiled filters reduce performance, increase the risk of fire and are unhygienic.
- Use the Con@ctivity function. The ventilation hood will switch on and off automatically. The ventilation hood will select the optimum power level for the cooking you are doing, which ensures low energy consumption.
- If you are operating the ventilation hood manually, please note the following:
  - Check the power level selected on the ventilation hood. A low power level is usually sufficient. Only use the Booster setting when necessary.
  - When a large volume of cooking vapors are being produced, switch to a high power level in good time. This is more efficient than operating the hood for longer to try to capture cooking vapors that have already been distributed throughout the kitchen.
  - Make sure that you switch off the hood after use. If cooking vapors and odors still need to be removed from the kitchen air after cooking, use the delayed shutdown function. The blower will switch off automatically after the selected delayed shutdown time.

# Cleaning and care

---

 Before proceeding with any maintenance or cleaning task, the ventilation hood must be disconnected from the power supply, see “IMPORTANT SAFETY INSTRUCTIONS”.

## Stainless steel housing

### General information

 The surfaces and control buttons are susceptible to scratching and chipping. Observe the following cleaning instructions.

- Clean all surfaces and control buttons using warm water and liquid dish soap. Apply with a sponge cloth.
- After cleaning, dry the surfaces with a soft cloth.

Avoid the following:

- Cleaners containing soda, acid or chloride, or cleaners containing solvents
- Abrasive cleaners such as scouring powder, scouring liquid, abrasive sponges such as pot scourers, or used sponges that still contain residues from abrasive cleaners

### Important information for appliances with stainless steel surfaces

Stainless steel surfaces can be cleaned with a non-abrasive cleaning agent designed specifically for use on stainless steel.

To prevent the surfaces from quickly becoming dirty again, we recommend treating them with a stainless steel care product (available from Miele).

### Important information for appliances with lacquered housing

Minor scratches on the surface are inevitable when cleaning the casing; they may be visible depending on the lighting in the kitchen.

### Special instructions for glass surfaces

- Glass surfaces can be cleaned using a cleaner specifically for use on glass.

## Grease filters



Risk of fire

Oversaturated grease filters are a fire hazard.

Clean the grease filters at regular intervals.

The re-usable metal grease filters in the appliance remove solid particles (grease, dust, etc.) from the kitchen vapors, preventing soiling of the ventilation hood.

The grease filters must be cleaned at regular intervals.

Heavily soiled grease filters hinder air extraction and will lead to increased levels of soiling in the ventilation hood and in the kitchen.

## Cleaning intervals

Accumulated grease solidifies over a longer period of time and makes cleaning more difficult. The grease filters should therefore be cleaned every 3 to 4 weeks.

The filter saturation indicator reminds you to regularly clean the grease filters by illuminating the grease filter symbol .

You can adjust the interval for the filter saturation indicator to match your cooking habits (see “Operation (Automatic and Manual modes)”).

## Removing the grease filters



When handling the grease filter, be careful not to drop it.

This can result in damage to the filter and the cooktop below.

Make sure you hold the filter securely at all times when handling it.

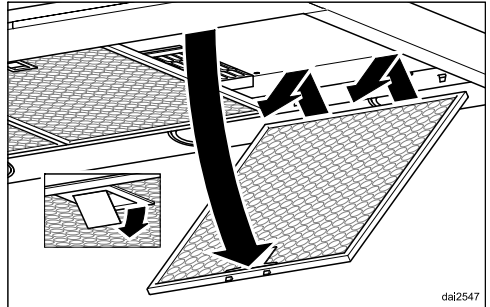

- To remove a grease filter, release the locking clip. Then, open the filter to a 45° angle, unhook it, and remove it from the hood.

## Cleaning the grease filters by hand

- Clean the filters with a soft nylon brush in a mild solution of hot water and dish soap. Do not use undiluted dish soap.

# Cleaning and care

## Unsuitable cleaning agents

Unsuitable cleaners can cause damage to the filter surfaces if used regularly. Do not use any of the following:

- Lime removers
- Abrasive powders or abrasive liquids
- Aggressive all-purpose cleaners and degreaser sprays
- Oven sprays

## Cleaning the grease filters in a dishwasher

- Place the grease filters upright or slightly inclined in the lower basket. Ensure the spray arm is not obstructed.
- Use a commonly available household dishwashing detergent.
- In a Miele dishwasher use the “Normal” program.

Depending on the detergent used, cleaning the filters in a dishwasher may cause the inside filter surfaces to become discolored. However, this will not affect the functioning of the grease filters in any way.

## After cleaning

- After cleaning, leave the filters on an absorbent surface to dry.
- When removing the filters for cleaning, also clean off any accessible oil or fat buildup from the housing. Doing so will prevent a fire hazard.
- Reinsert the grease filters. When inserting the grease filters, make sure that the locking clip is facing outward.

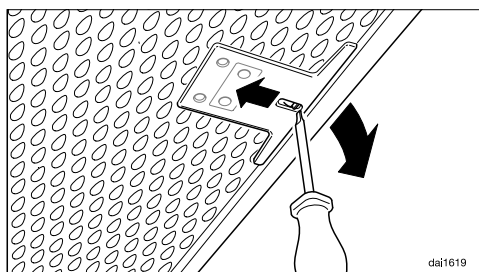

- If a grease filter is inadvertently fitted upside down, insert a small screwdriver blade into the slit to disengage the clip.

## Resetting the filter saturation indicator for the grease filters

Once cleaning is complete, the filter saturation indicator must be reset.

- While the blower is turned on, touch the grease filter control  for approx. 3 seconds, until only the **1** is flashing.

The grease filter symbol  goes out.

When cleaning the grease filters before the full operating time has elapsed:

- Touch the grease filter control  for approx. 6 seconds, until only the **1** is flashing.

## Replacing the grease filter

Regular usage and cleaning can cause the filter surfaces to become worn.

If you identify any damage, replace the grease filters.

Grease filters are available to order via Miele Customer Service (see end of these operating instructions for contact details) or from your Miele dealer.

## OdorFree Charcoal Filter

With recirculation mode, a charcoal filter must be fitted in addition to the grease filters. The charcoal filter is designed to absorb cooking odors.

The charcoal filter is fitted in the canopy above the grease filters.

### How to install/replace a charcoal filter

- Remove the grease filters before fitting or replacing a charcoal filter.
- Take the charcoal filter out of its packaging.

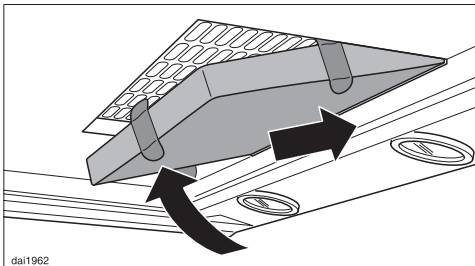

- Slide the filter into the back of the intake frame, then push the front of the filter up into the frame.
- Reinsert the grease filters.

### When to change the OdorFree Charcoal Filter

- Replace the charcoal filter when it no longer absorbs kitchen odors effectively.  
It should be replaced at least every 6 months.

The filter saturation indicator reminds you to regularly replace the charcoal filter by illuminating the charcoal filter symbol .

### Resetting the filter saturation indicator for the charcoal filters

After changing the charcoal filters, the filter saturation indicator must be reset.

- Touch the charcoal filter control  for approx. 3 seconds with the blower switched on until only the indicator light for level 1 is flashing.

The charcoal filter symbol  will go out.

If you want to replace the charcoal filter **before** the full operating time elapses:

- Touch the charcoal filter control  for approx. 6 seconds until only the indicator light for level 1 is flashing.

### Disposing of charcoal filters

- Used charcoal filters can be disposed of with normal household waste.

Charcoal filters are available to order via the Miele Web Store (see end of this booklet for contact details), or from your Miele dealer.

The charcoal filters are listed under “Technical data” at the back of this booklet.

# Installation

## Before installation

 Before installation, it is important to read the information contained in this chapter and in the “IMPORTANT SAFETY INSTRUCTIONS” chapter.

## Removing the protective film

The housing components are covered by a protective film to prevent them from damage during transport.

- Please remove this film before installing the housing components. It can be peeled off easily without any additional tools.

## Installation materials

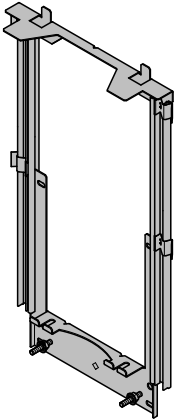

### Telescopic wall bracket

for securing the ventilation system on the wall.

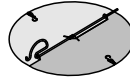

### 1 non-return flap

for installation in the exhaust vent on the motor (not needed for recirculation mode)



### 6 screws 5 x 60 mm and 6 plugs 8 x 50 mm

for securing the ventilation hood on the wall.

 The screws and plugs are designed for use in solid walls only. Use different fasteners for other wall construction types. Make sure that the wall can support the load.



### 2 M6 locknuts

for mounting the appliance unit



### 2 screws 3.9 x 7.5 mm

for securing the duct cover

08165470

5/3/mer-026/8x30

00031652

00256130

08561000

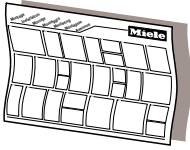

dina3mie

## Installation plan

See the installation plan for details of the individual steps involved in the installation of this appliance.

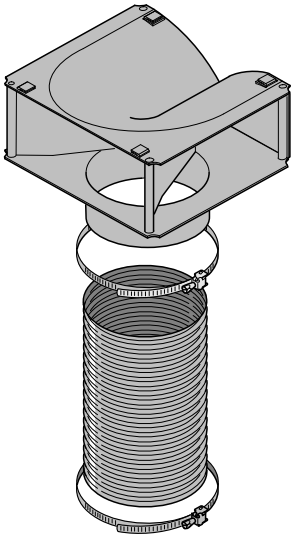

DJW20

## Conversion kit for recirculation mode

The conversion kit contains an exhaust grille, hose, and hose clips (not supplied, but available as an optional accessory. See “Technical data”).

# Installation

## Appliance dimensions

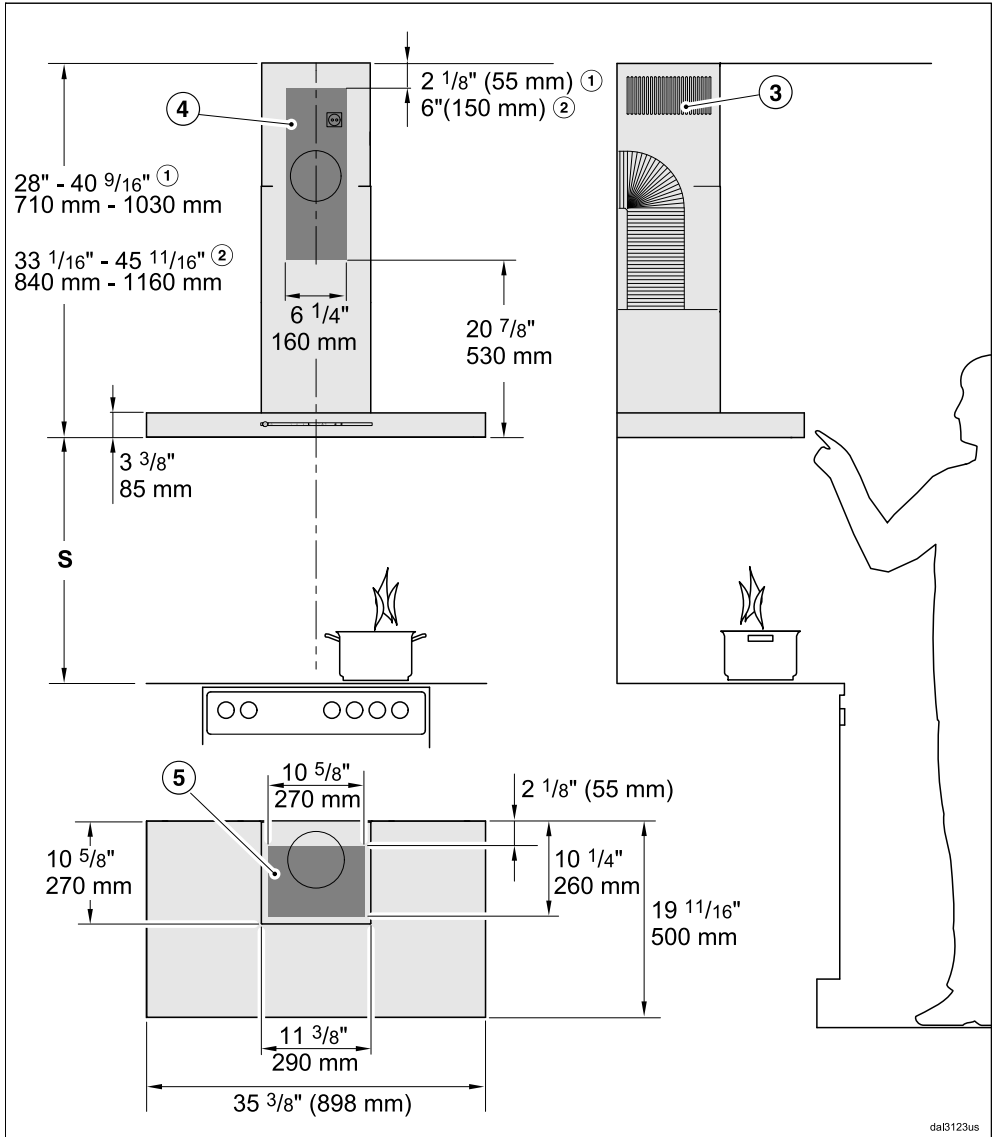

The drawing is not to scale

- ① Extraction mode
- ② Recirculation



- ③ Air vent positioned at the top for recirculation
- ④⑤ Installation area (only ④ is required for recirculation operation). Wall or ceiling area for the ducting cutout and for the electrical outlet. For recirculation operation, only an electrical outlet needs to be installed.

Exhaust connection  $\varnothing$  6" (150 mm)

## Distance between cooktop and ventilation hood (S)

Provided a larger distance is not given by the manufacturer of the cooktop, follow the minimum safety distances between a cooktop and the bottom of the hood.

Please also observe the information contained in the "IMPORTANT SAFETY INSTRUCTIONS" section.

Cooking appliance	Minimum distance S	
	Miele appliance	Non-Miele appliance
Electric Cooktops	24" (610 mm)	
Electric Barbeques and Fryers	26" (660 mm)	
Multiburner Gas Cooktops ≤ 43,000 BTU/hr (12.6 kW), no burner > 15,000 BTU/hr (4.5 kW).	26" (660 mm)	30" (760 mm)
Multiburner Gas Cooktops ≤ 73,800 BTU/hr (21.6 kW), no burner > 16,500 BTU/hr (4.8 kW)	30" (760 mm)	
Multiburner Gas Cooktops > 73,800 BTU/hr (21.6 kW), or one of the burners > 16,500 BTU/hr (4.8 kW)	Not possible	
Single Burner Gas Cooktops ≤ 20,500 BTU/hr (6 kW)	26" (660 mm)	30" (760 mm)
Single Burner Gas Cooktops > 20,500 BTU/hr (6 kW) ≤ 27,600 BTU/hr (8.1 kW)	30" (760 mm)	
Single Burner Gas Cooktops > 27,600 BTU/hr (8.1 kW)	Not possible	

# Installation

## Installation recommendations

- A distance of at least 26" (660 mm) is recommended above electric cooktops to provide more workspace and easier cooking under the hood.
- When selecting an installation height, always take the user height into consideration. Users should have ample space to work comfortably on the cooktop and reach the ventilation hood controls with ease.
- Please note that the greater the distance from the cooktop, the less effective the hood is at drawing in the cooking vapors.
- To achieve optimum vapor extraction, the hood must be centered over the cooktop, not to the side.
- The cooktop should be no wider than the hood. Preferably, it should be narrower for better extraction.
- The mounting area must be easily accessible. The ventilation hood should be easy to reach and disassemble in case a service call is necessary. This should be taken into consideration when planning the position of cabinetry, shelves, ceilings or decorative elements in the vicinity of the ventilation hood.

## Drilling diagram for wall mounting

- Please follow the directions given in the installation instructions supplied for drilling.

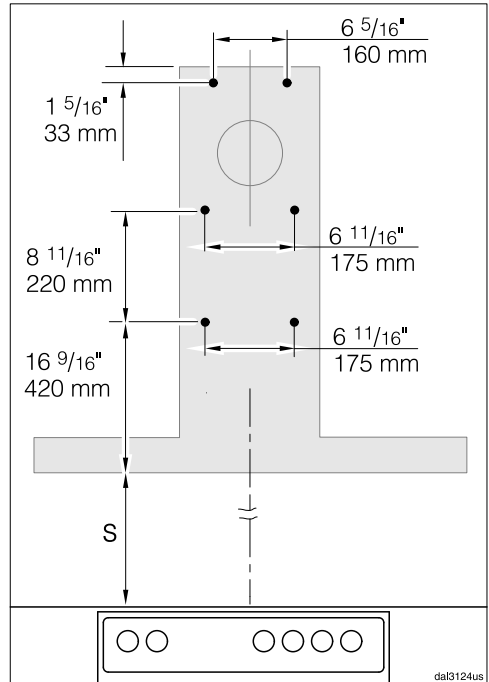

- When installing a custom back wall with pre-drilled holes, please refer to the drilling distances in the drawing above (screws  $\varnothing \frac{3}{16}''$  (5 mm)).

## Plywood backing

The majority of the weight of the installed ventilation system will be supported by the lower retaining plate. It must be firmly attached to the stud framing behind the drywall. If studs are not available in the required locations, a plywood backing (min. ½" (13 mm) thick) spanning at least two studs must be installed.

Failure to adequately support the weight as stated may result in the ventilation system falling off the wall, causing personal injury and property damage.

If plywood backing is not needed, proceed to the included "Installation diagram".

## To install a plywood backing

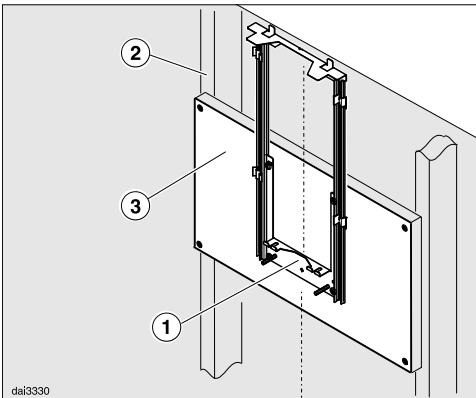

- Determine and mark the location of the retaining plate ① for the canopy as outlined on the "Installation diagram".

- Make a cutting line 3" (76 mm) above and 3" (76 mm) below the outline of the retaining plate.
- Find the studs ② to the left and right of the mounting location by tapping the wall or using a stud finder.
- Mark a vertical cutting line along the center of each stud.

**CAUTION:** When cutting or drilling into the wall or ceiling, do not damage electrical wiring and other hidden utilities.

- Remove the drywall between the cutting lines and replace it with plywood ③ of a matching thickness (min. ½" (13 mm) thick). Tape the joints and refinish the wall.
- Proceed to the enclosed "Installation diagram" to complete the installation.

# Installation

## Air venting

**WARNING:** Danger of toxic fumes. Gas cooking appliances release carbon monoxide that can be harmful or fatal if inhaled.

To reduce the risk of fire and to properly exhaust air, the exhaust gases extracted by the hood should be vented outside of the building only.

Do not vent exhaust air into spaces within walls or ceilings or in attics, crawl spaces or garages.

To reduce the risk of fire, only use metal ductwork.

Please read and follow the “IMPORTANT SAFETY INSTRUCTIONS” to reduce the risk of personal injury. Follow all local building codes when installing the hood.

Only use smooth pipes or flexible ducting made from approved non-flammable materials for ducting.

To achieve the most efficient air throughput with the lowest noise levels, please note the following:

- The diameter of the vent ducting must not be smaller than the cross-section of the vent collar (see “Appliance dimensions”). This applies in particular when using flat ducting.
- The ducting should be as short and straight as possible.
- Only use wide radius bends.
- The ducting must not be kinked or compressed.

- All connections must be strong and airtight.
- If the ducting has flaps, these must be opened whenever the ventilation hood is switched on.

Any constriction of the air throughput will reduce extraction performance and increase operating noise.

## Ventilation stack

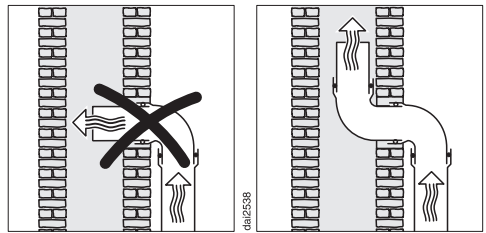

If the exhaust air is to be ducted into a flue, the ducting must be directed in the flow direction of the flue.

If the flue is used by several ventilation units, the cross-section of the flue must be large enough.

## Non-return flap

- Use a non-return flap in the vent system.

A non-return flap ensures that when the ventilation hood is not in operation, the duct is closed to prevent unwanted exchange of room air and outside air.

If the exhaust is ducted through an outside wall, a Miele wall vent or roof vent (available as an optional accessory) is recommended. Both of these have a built-in non-return flap.

If the on-site vent system does not have a non-return flap, one is supplied with the ventilation hood.

The non-return flap is installed in the exhaust socket of the fan.

## Condensate

If the ducting is to run through cool rooms or ceiling space, for example, the significant variations in temperature between the different areas can cause condensate to form. Insulate the ducting to reduce temperature variations.

If the ducting is to be laid horizontally, it must be laid with a downwards sloping gradient of at least  $\frac{3}{8}$ " (1 cm) per meter. This is to ensure that condensate cannot drain back into the ventilation hood.

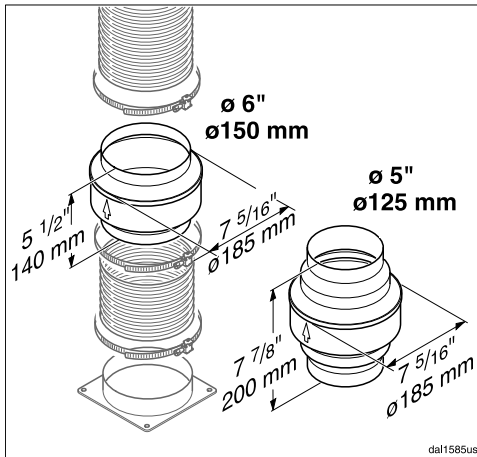

In addition to insulating the ducting, it is advisable to also install a condensate trap for collecting and evaporating any potential condensate.

Condensate traps for 5" (125 mm) or 6" (150 mm) diameter ducting are available as optional accessories.

When installing a condensate trap, ensure that it is positioned vertically and as closely as possible to the ventilation hood above the exhaust vent. The arrow on the casing indicates the direction of airflow.

Miele will not accept warranty claims for any functional defects or damage caused by inadequate ducting.

## Reducing Collar

(optional accessory)

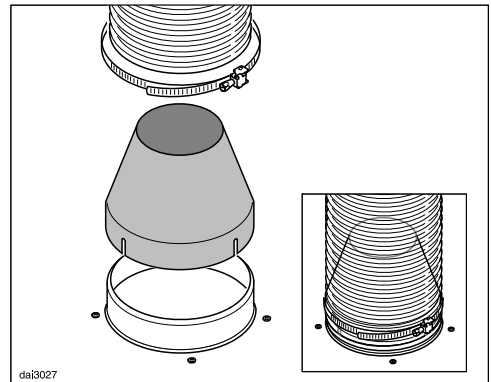

If you would like to reduce the environmental impact of your ventilation system by limiting the CFM output the Reducing Collar can be installed. It reduces the air flow to less than 400 CFM. Check local building codes for max. CFM requirements.

- Push the Reducing Collar on the exhaust port of the blower.
- Push the exhaust hose over it.
- Secure both with a hose clamp.

# Installation

## Electrical connection

**WARNING: TO REDUCE THE RISK OF FIRE, ELECTRIC SHOCK, OR INJURY TO PERSONS, OBSERVE THE FOLLOWING:**

All electrical work should be performed by a qualified electrician in strict accordance with national regulations (for USA: ANSI-NFPA 70) and local safety regulations.

Installation, repairs and other work by unqualified persons could be dangerous.

Ensure that power to the appliance is OFF while installation or repair work is performed.

Verify that the voltage, load and circuit rating information found on the data plate (see "Technical Service"), match the household electrical supply before installing the hood.

Use only with ventilation hood cord-connection kits that have been investigated and found acceptable for use with this model hood.

If there is any question concerning the electrical connection of this appliance to your power supply, please consult a licensed electrician or call Miele's Technical Service Department.

**WARNING: THIS APPLIANCE MUST BE GROUNDED**

## Grounding Instructions

**WARNING - Improper grounding can result in a risk of electric shock.**

This appliance must be grounded. In the event of an electrical short circuit, grounding reduces the risk of electric shock by providing a path of least resistance. This appliance is equipped with a cord having a grounding wire with a grounding plug.

If there is any doubt, have the electrical system of the house checked by a qualified electrician.

Do not use an extension cord. If the power supply cord is too short, have a qualified electrician install an outlet near the appliance.

- The plug must be plugged into an outlet that is properly installed and grounded.

**WARNING - Grounding instructions (Canada)**

The grounding-type attachment plug shall be connected to a grounding-type receptacle installed in accordance with CSA C22.1-12, Canadian Electrical Code, Part I.

Information to help you rectify faults yourself and about Miele spare parts can be found at [www.miele.com/service](http://www.miele.com/service).

## **Contact in the event of a fault**

In the event of a fault which you cannot remedy yourself, please contact your Miele dealer or Miele Customer Service.

You can book a Miele Service Call online at [www.miele.com/service](http://www.miele.com/service).

Contact information for Miele Customer Service can be found at the end of this document.

Please quote the model identifier and serial number of your appliance (SN) when contacting Miele Customer Service. Both pieces of information can be found on the data plate.

## **Location of the data plate**

The data plate is visible once you have removed the grease filters.

## **Appliance warranty and product registration**

You can register your product and/or view the manufacturer's warranty terms and conditions for Miele appliances and vacuum cleaners at [www.mieleusa.com](http://www.mieleusa.com).

# Technical data

Blower motor	350 W
Overhead lighting	3 x 3 W
Total connected load	359 W
Supply voltage, frequency	120 V AC, 60 Hz
Fuse	15 A
Power cord length	2.5 ft (0.75 m)
Weight	57.2 lbs (26 kg)

## WiFi module

Frequency range	2.400–2.4835 GHz
Maximum transmission power	< 100 mW

## ZigBee® module

Frequency band	2.405–2.48 GHz
Maximum transmission power	< 10 mW

## Optional accessories for recirculation mode

DUW 20 conversion kit and DKF 12-900 charcoal filter



### WiFi module EK037

FCC ID: 2ACUWEK037

IC: 5669C-EK037

### ZigBee® module EK038

FCC ID: 2ACUWEK038

IC: 5669C-EK038

This device complies with Part 15 of the FCC Rules and with Industry Canada licence-exempt RSS standard(s). Operation is subject to the following two conditions: (1) this device may not cause harmful interference, and (2) this device must accept any interference received, including interference that may cause undesired operation.

da3c9f1







**Please have the model and serial number  
of your appliance available when  
contacting Customer Service.**

---

## **U.S.A.**

**Miele, Inc.**

### **National Headquarters**

9 Independence Way  
Princeton, NJ 08540  
[www.mieleusa.com](http://www.mieleusa.com)

### **Customer Support**

Phone: 888-99-MIELE (64353)  
[info@mieleusa.com](mailto:info@mieleusa.com)

### **International Headquarters**

Miele & Cie. KG  
Carl-Miele-Straße 29  
33332 Gütersloh  
Germany

## **Canada**

**Importer  
Miele Limited**

### **Headquarters and Miele Centre**

161 Four Valley Drive  
Vaughan, ON L4K 4V8  
[www.miele.ca](http://www.miele.ca)

### **Customer Care Centre**

Phone: 1-800-565-6435  
905-532-2272  
[customercare@miele.ca](mailto:customercare@miele.ca)

DA 6698 W

en-US

M.-Nr. 12 253 910 / 01