

## Cube- 36"

## Specification & Installation Guide

### Features

- Wall hung 36" vanity : 28"(712mm)H x 22"(560mm)D x 35-5/8"(905mm)W
- Furniture grade plywood layered with solid wood veneer and protected with several coats of polyurethane (No particle board or MDF used)
- Matching finish inside out
- Two fully adjustable drawers with full-extension soft-close European hardware
- Drawers include adjustable tempered glass dividers and retainers

### Colors/Finishes

- Ash Grey (AG)
- Glossy White (GW)
- Walnut (WA)

### Top/Basin options

- White, Soft Grey or White Carrara Quartzstone™ top & White ceramic basin
- Glossy White X-Stone top/basin
- Glossy or Matte White X-Stone flat countertop
- Tempered glass top and ceramic basin

### Package Dimensions

40" x 26" x 30"

### Weight

152 lbs. / 69 kgs

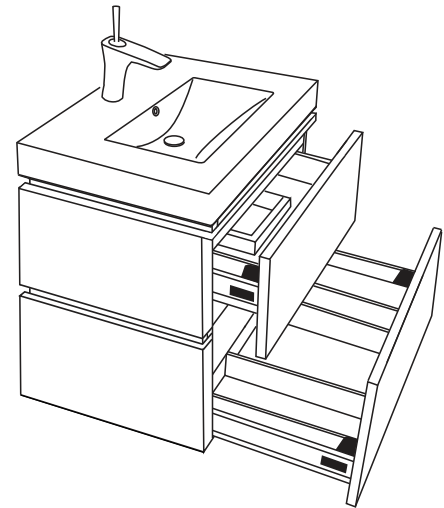
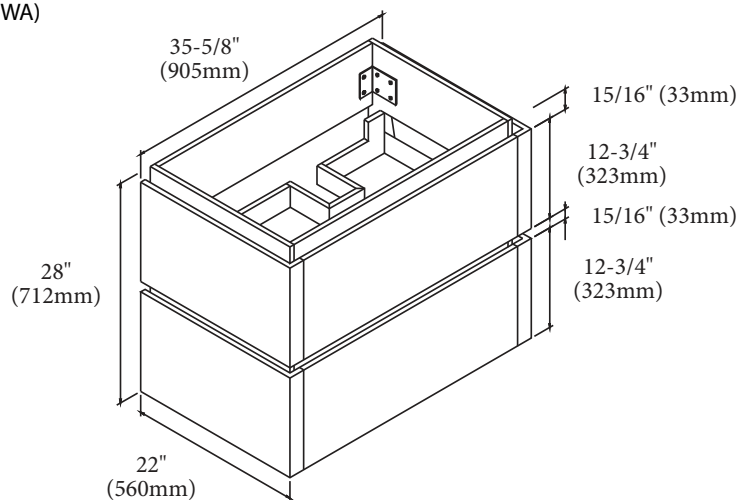

### SIDE VIEW

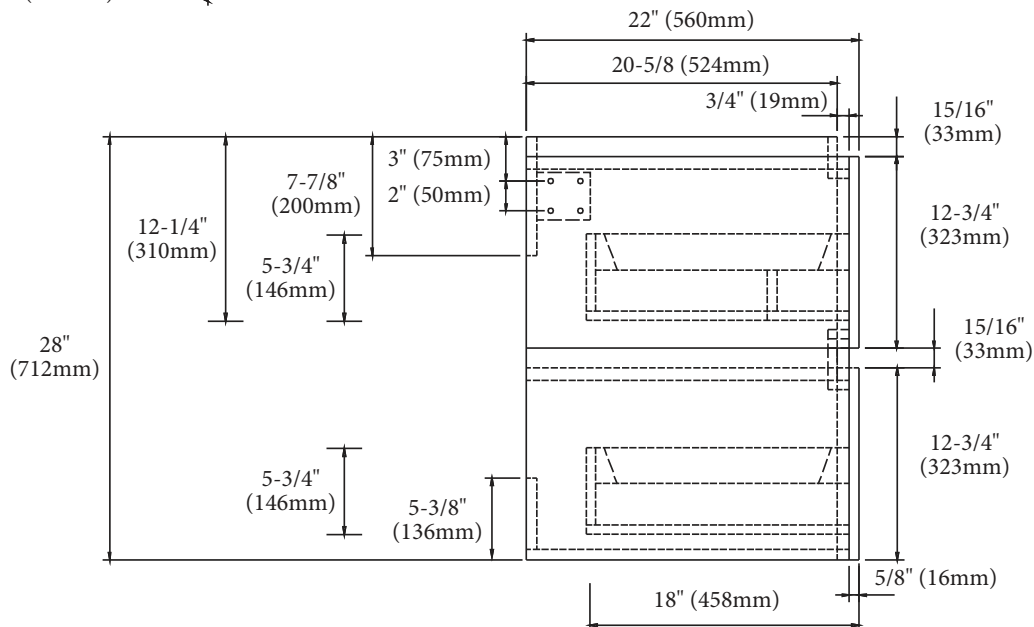

**For clarification, please contact Madeli Customer Care at (800)-819-6988 or (305)-718-8817 Ext. 1**

All dimensions are approximate and subject to standard tolerance. Specifications subject to change without prior notice.

## Cube - 36"

## Specification & Installation Guide

### TOP VIEW

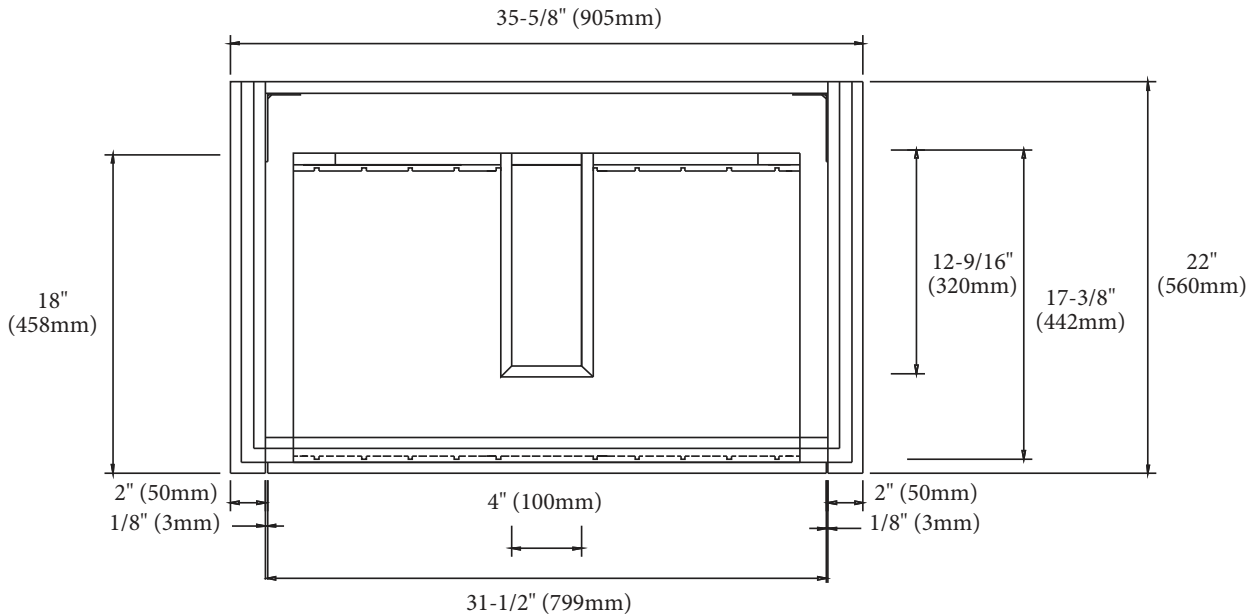

### BACK VIEW

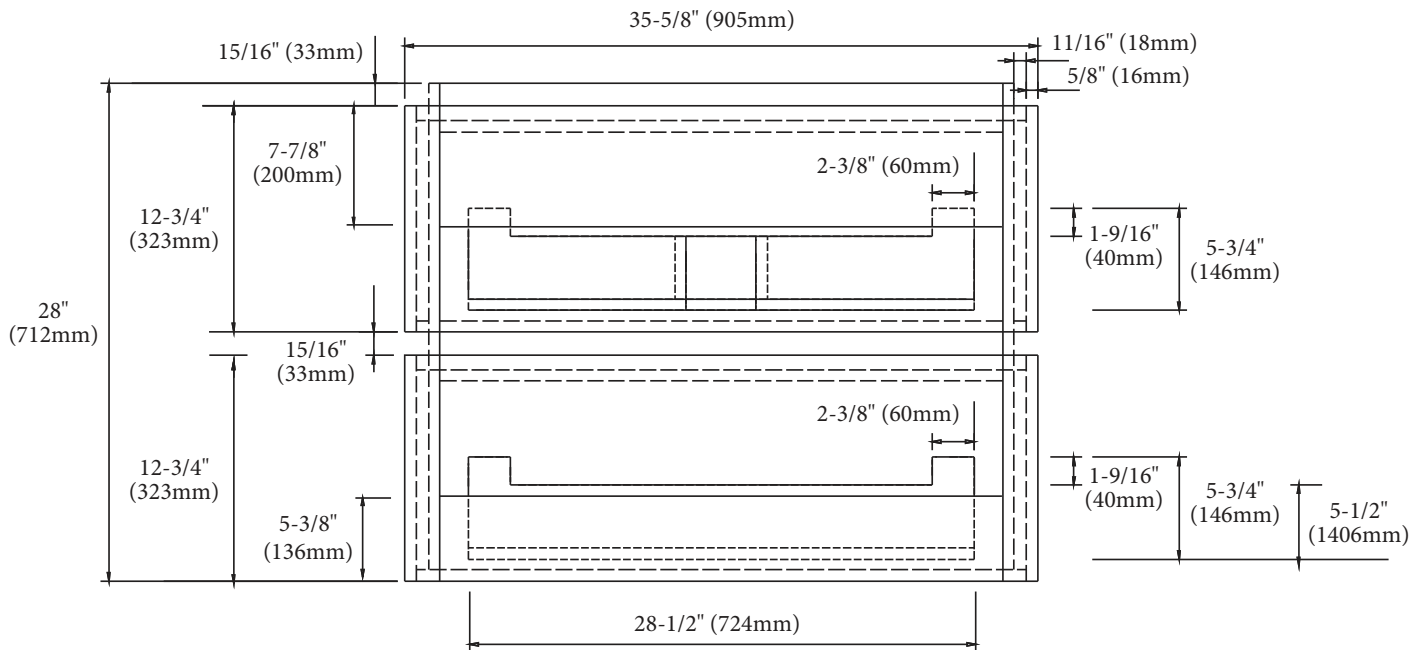

## Cube - 36"

## Specification & Installation Guide

### FRONT VIEW

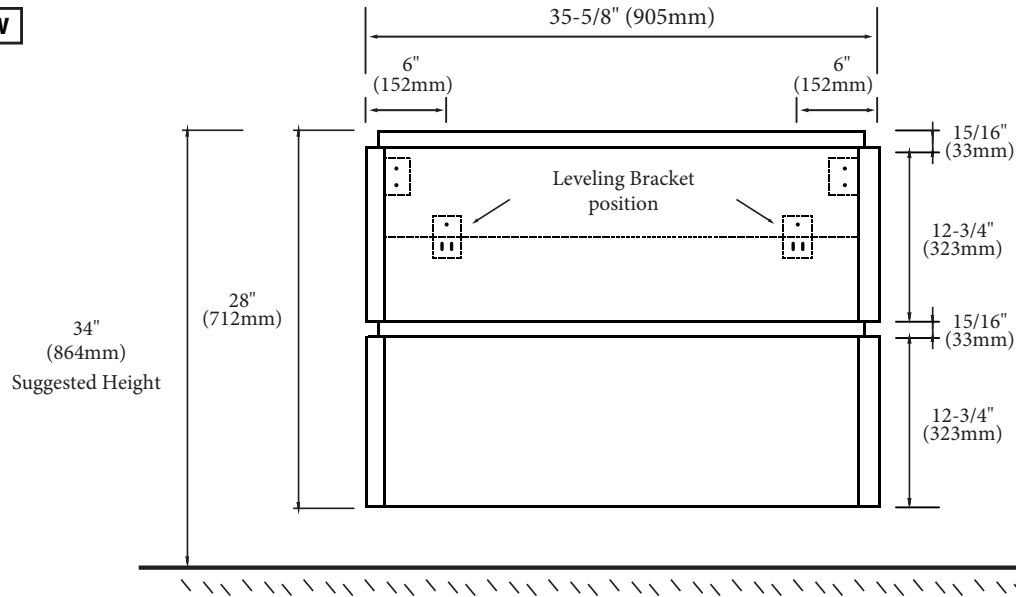

### TYPICAL INSTALLATION



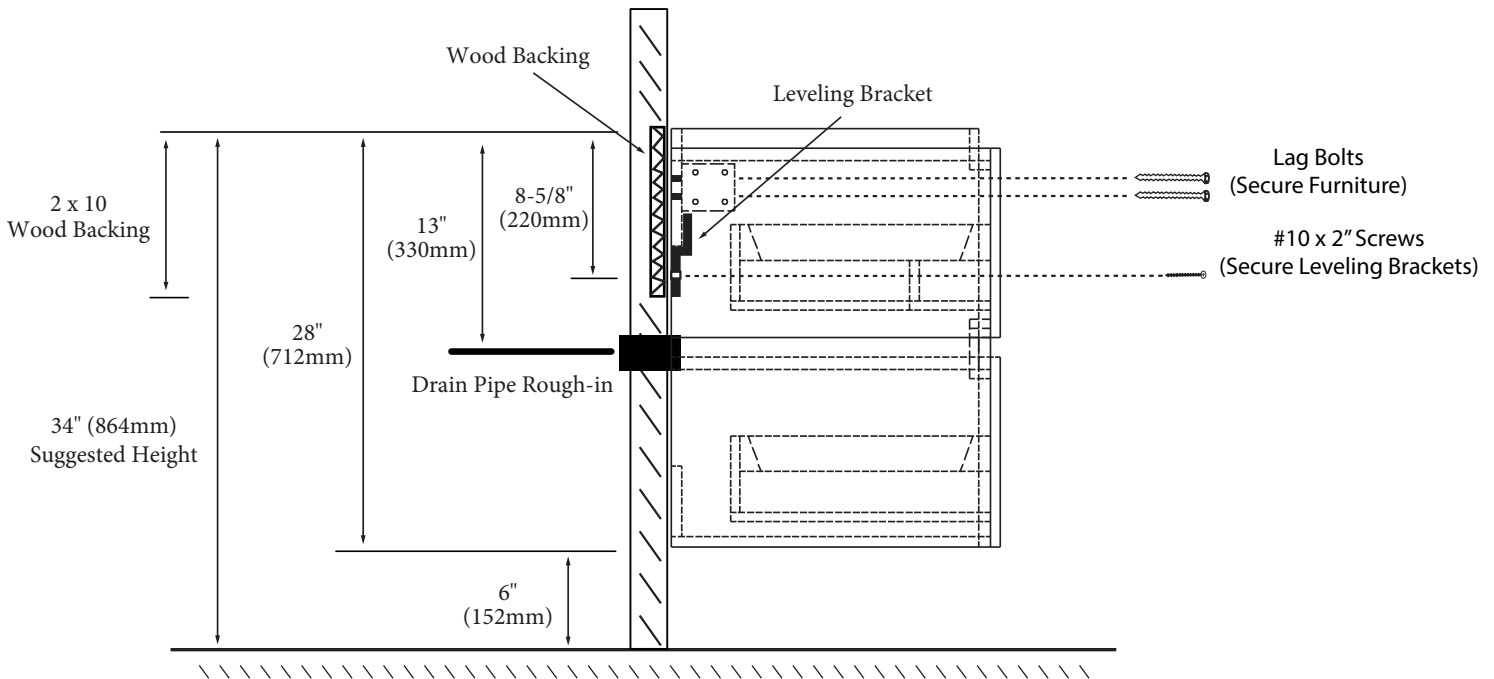

The typical dimensions shown will result in vanity cabinet height of 34" (864mm). Depending on the countertop selected, the total height will vary from 35-1/4" (895mm) to 36-1/2" (927mm). For above-counter vessels with typical heights between 4" and 6", it is suggested to lower the cabinet to 31" (785mm). If alternate heights are desired, adjust the rough-in and backing material heights using the dimensions provided.



## Cube - 36"

## Specification & Installation Guide

### INSTALLATION INSTRUCTIONS

Item	Leveling Bracket	#10 x 2" Screws	Anchors	Lag Bolt 5/16 x 2-1/2"	Silicone (not included)
Qty.	2	4	8	8	1
					

### STEP 1

#### Wall Preparation

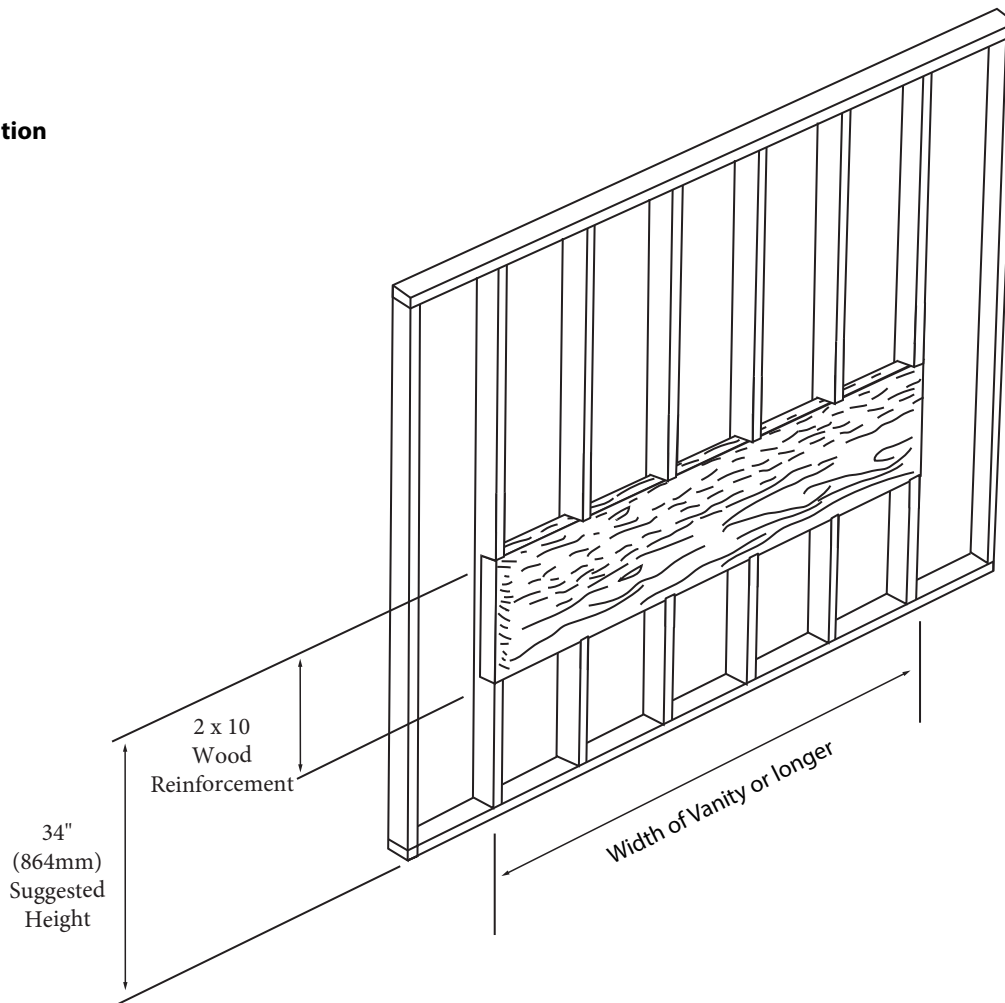

**For clarification, please contact Madeli Customer Care at (800)-819-6988 or (305)-718-8817 Ext. 1**

All dimensions are approximate and subject to standard tolerance. Specifications subject to change without prior notice.

## Cube - 36"

## Specification & Installation Guide

### STEP 2

#### Install leveling bracket

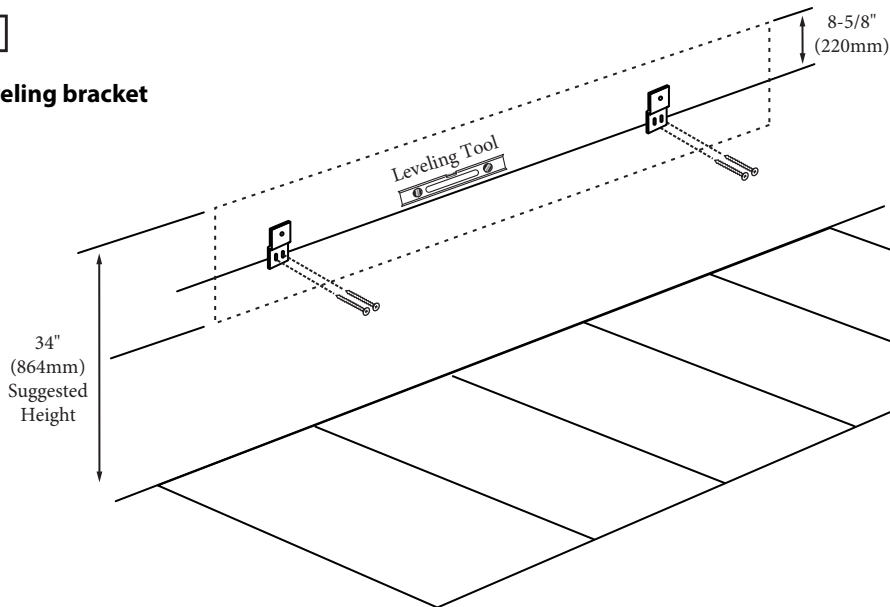

### STEP 3

#### Place vanity on leveling bracket

Leveling brackets are only to level the vanity. They are not designed for permanent support. Cabinet needs to be secured to wood backing material.

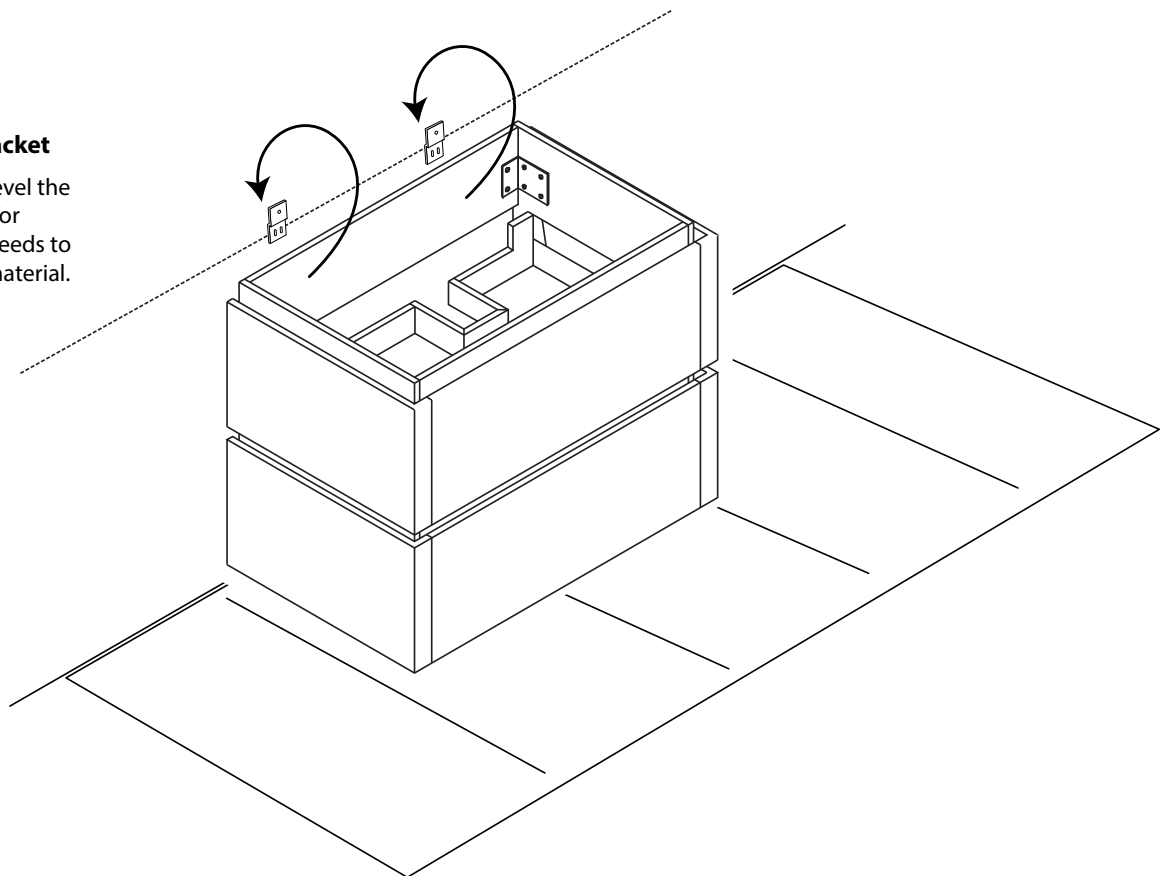

## Cube - 36"

## Specification & Installation Guide

### STEP 4

Secure vanity to wood reinforcement backing

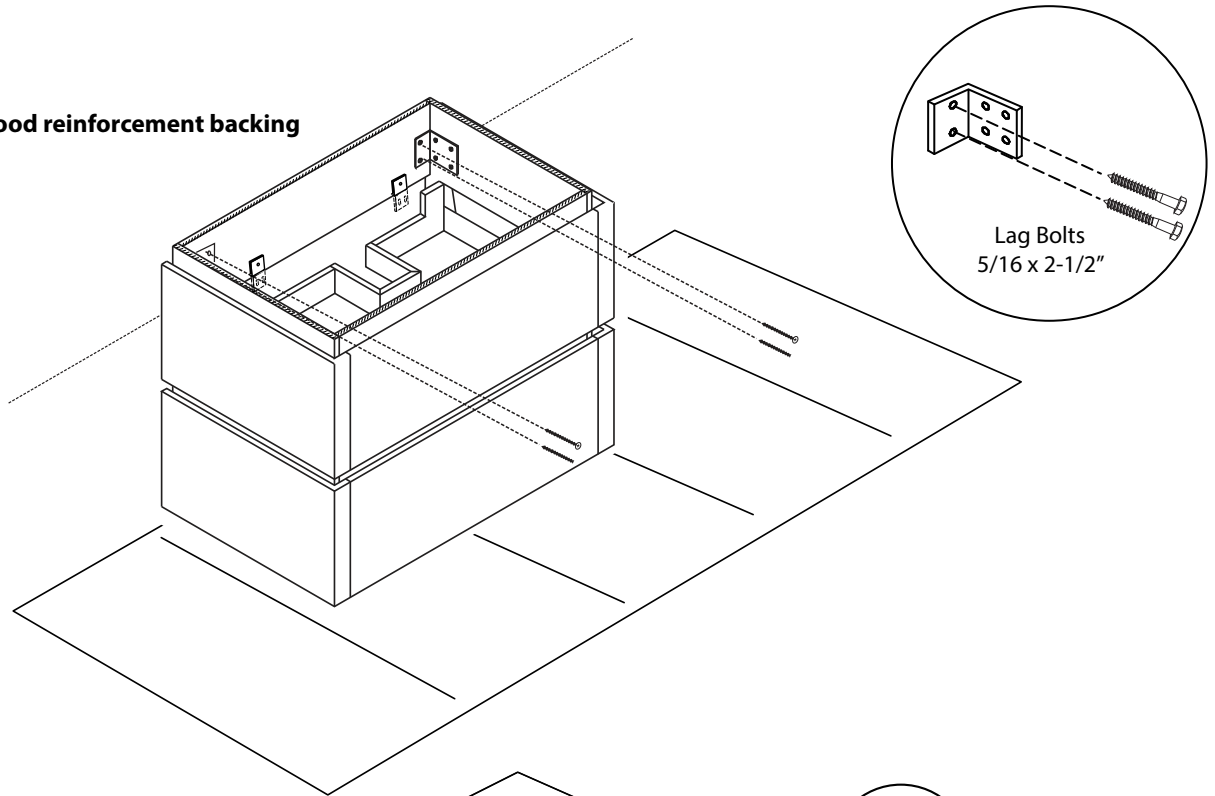

### STEP 5

Install countertop with Silicone

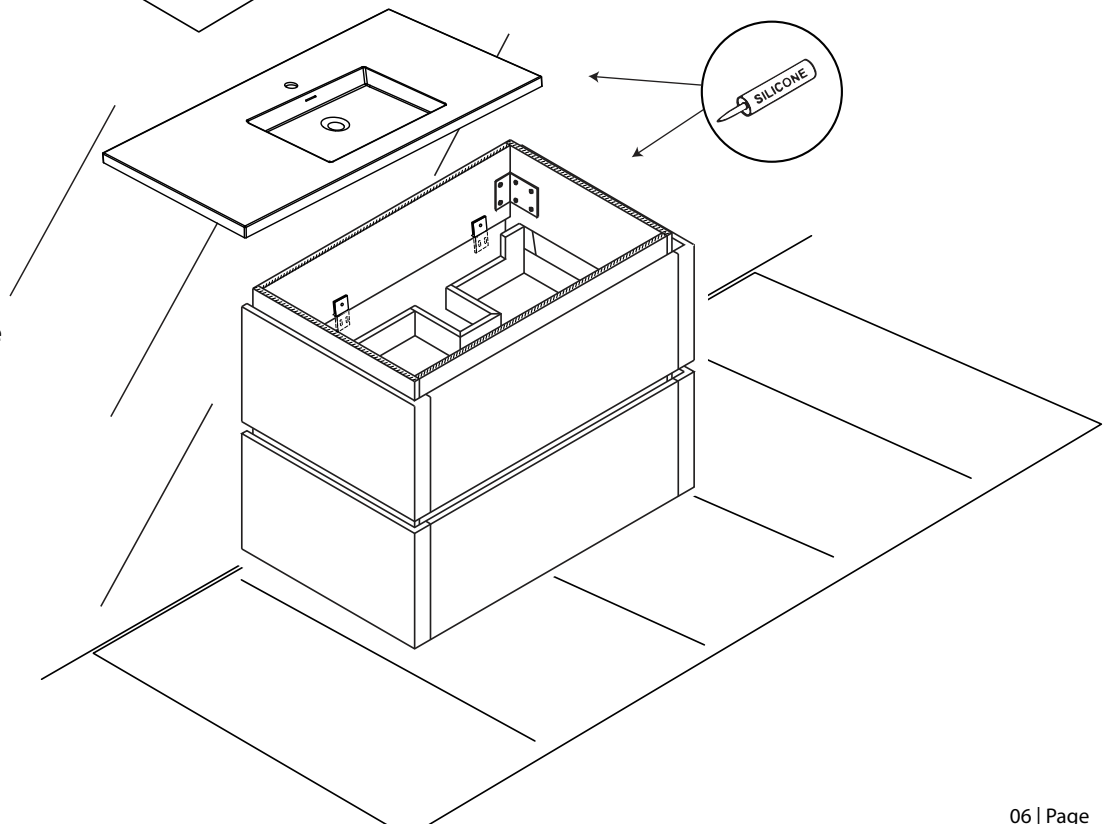

For clarification, please contact Madeli Customer Care at (800)-819-6988 or (305)-718-8817 Ext. 1  
All dimensions are approximate and subject to standard tolerance. Specifications subject to change without prior notice.