

PerfectSteam Generator

Product Specifications



Model LX10

SPECIFICATIONS

Input Voltage.....208-240VAC Single Phase
 Kilowatt Rating.....10.0
 Maximum Amperage.....46 AMPS
 Water Inlet.....3/8" NPT
 Steam Outlet.....1/2" NPT
 Electrical connection.....Hard-wired

Maximum Room Size (cubic Feet).....240

The steam generator shall approximately be 17.5" x 8" x 9.5" in dimension. The generator tank shall be made from stainless steel the controller 5.5" x 3.4" x 3/4", and the steam head 2.5"Dia x 2".

FEATURES

- Requires LXTTC-OSS Steam Control. Available in four finishes
- Simple Sized – no complicated formulas
- Constant steam at a constant rate (no steam lags or bursts)
- 1 year in home, five year “no questions asked” factory warranty
- Can be plumbed 50 feet from the shower enclosure without having to purchase a larger kW unit
- Time, temperature, memory, and clock control; all metal construction – not plated plastic

Shipping Information:

Weight.....21 lbs.
 Length.....20 in.
 Width.....7 in.
 Height.....11 in.

INSTALLATION NOTES

Install this generator according to the supplied installation guide. Follow local plumbing and electrical codes. Unit must be accessible.

Generator is factory sized: L x W x H = Cubic Feet. Choose the appropriate generator. For every additional foot of ceiling height over 8 ft, use the next larger generator. Always round up when calculating the total cubic feet.

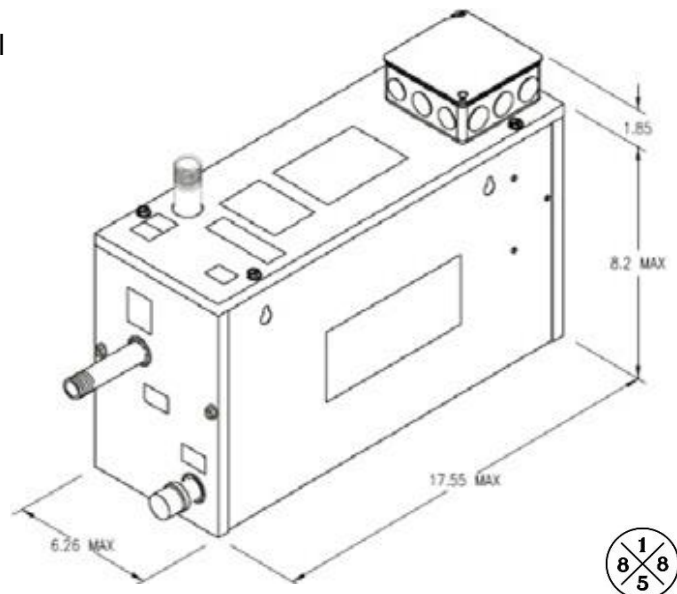

Contact your sales representative for more information or visit our website at luxartcollection.com