



AG18B-01 Shown with D005 UB



AG18B

Artisan Glass – Dune White Medium Rectangle

DETAILS

Installation Type: Undermount

Material: Glass

Standard 1.5" Drain, No Overflow

Dimensions are approximate [OD: 20" x 14" x 4", ID: 18" x 12"]

Each Sink is hand-crafted; no two sinks will be the same





All handmade glass sinks are expected to have inherent and unique markings such as air bubbles, leaf marks, surface pinholes and maker's marks

See our "[Artisan Glass Fact Sheet](#)" for additional details.

SINK FINISH

	01	White
---	-----------	-------

AVAILABLE DRAINS

	D004	Grid Strainer
	D005	Lift & Turn
	D006	Pop-up with Horizontal Lift Rod
	D011 – D017	Decorative Grid Strainers

DO NOT use compression (i.e. Click-Clack, Press-to-Close/Open) type drains. Hand-tighten drains.

INSTALLATION

Use silicone adhesive to adhere sink to countertop. Clean any excess silicone from sink surface. Do not install sink using clips. **Hand-tighten drain – do not overtighten.** Conversion Kit for drain installation is included with each sink

CARE

Mild based glass cleaner may also be used. No harsh or acidic cleaning products. Soap and water for everyday cleaning. Non-ammonia.

WARRANTY

Linkasink warranties our product to be free from manufacturing defect for the life of the product. Warranty does not cover improper care, neglect or abuse or normal wear-and-tear

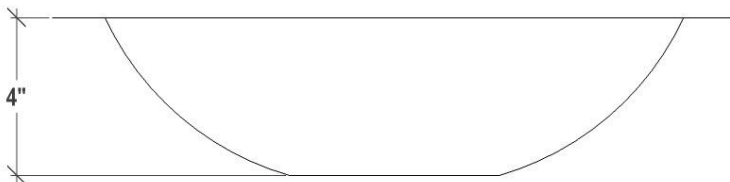
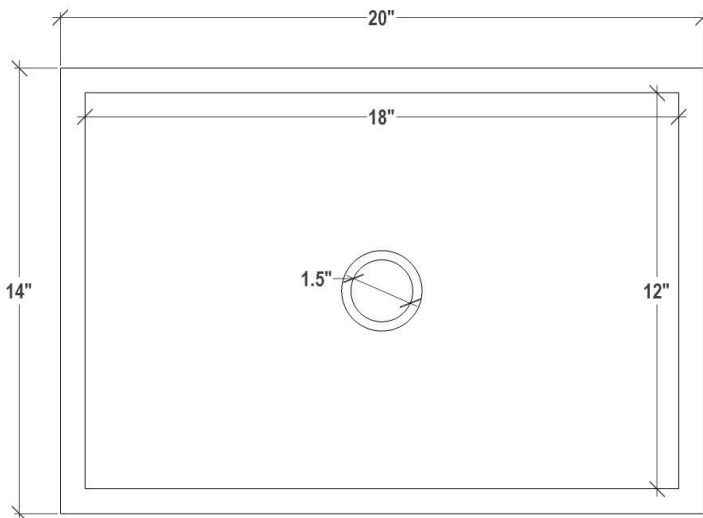

DIMENSIONS WILL VARY

DO NOT use this sheet as a guide for countertop cuts. Due to the handmade nature of each product, templates are not provided.

P: 602.971.2502
E: sales@linkasink.com

Linkasink may make changes to specifications without notice.
Visit linkasink.com for updated specification sheet.

03/08/2023