

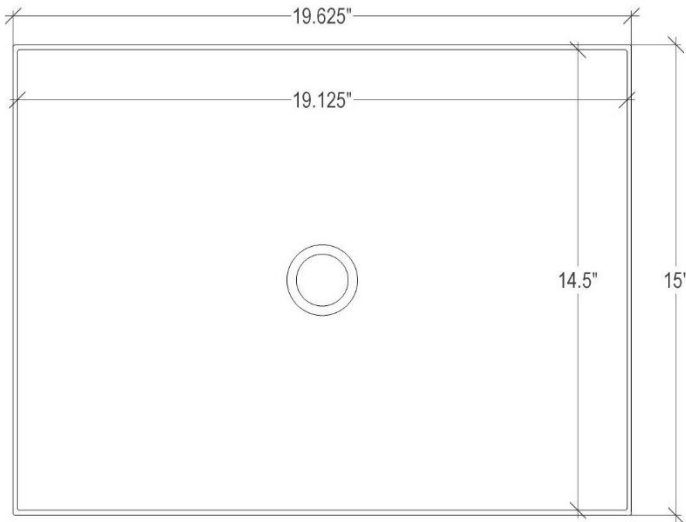

Shown in G

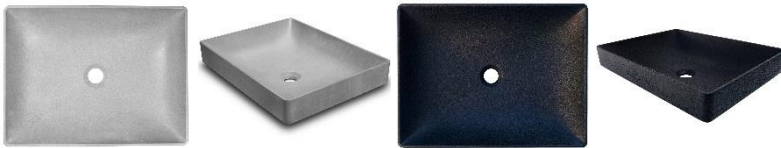

AC02

Lily

DETAILS

Installation Type: Semi-Recessed Vessel



Glass Fiber Reinforced Concrete

(Each sink is Hand Crafted; no two sinks will be the same.)





1.5" Drain Opening

No Overflow

AVAILABLE FINISHES

	G	Gray
	BLK	Black

AVAILABLE DRAINS

	D004	Grid Strainer
	D005	Lift and Turn
	D006	Pop-Up with Horizontal Lift Rod
	D101 – D720	Decorative Drains
	D011 – D017	Decorative Grid Strainers

INSTALLATION

Drain should be installed first. A conversion kit for drain installation is provided with each sink with 1.5" drain opening. Cut opening in countertop large enough for extruded part of sink to sit into countertop. Use 100% silicone to adhere sink to countertop. Clean any excess silicone from sink surface.

CARE

Concrete sinks are crafted from glass fiber reinforced concrete (GFRC). Linkasink hand-etches then seals each sink with a 7 Step impregnating sealer. Use Windex® with Vinegar for cleaning as needed. The sink should not be exposed to harsh or acidic chemicals, cleaners or scrubbers.

WARRANTY

Linkasink warranties our product to be free from manufacturing defect for the life of the product. Warranty does not cover abuse.

DIMENSIONS WILL VARY

DO NOT use this sheet as a guide for countertop cuts. Due to the handmade nature of each product, templates are not provided.