



4580 W Roosevelt Rd. Hillside, IL 60162

Phone: 312-733-1098 Fax: 708-234-1351

SPECIFICATIONS

**MODEL S-SS-S3118-0Ri-18 (18 Gauge)
S-SS-S3118-0Ri-16 (16 Gauge)**

GENERAL

Fine quality Hand-Made sink formed of 18 gauge or 16 gauge, type 304 nickel bearing stainless steel.

DESIGN FEATURES

Bowl depth 9 inches with inside bowl dimensions 29" X16" Over all 31" X 18"

Finish: Inside bowl surfaces polished to a uniform satin finish.

Underside: Five high density sound absorption pads covered with a thick rubberized insulation layer on all bottom surfaces.

Other: Drain opening 3 1/2".

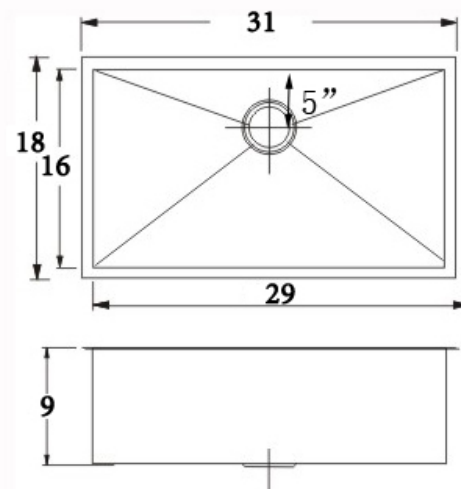

cUPC Certified

Minimum Cabinet Size: 33"

Product shall be specified as S-SS-S3118-0Ri-18
or S-SS-S3118-0Ri-16

OPTIONAL ACCESSORIES:

Stainless Steel Bottom Grid: G3S3118

Stainless Steel Colander: A-CLDR2

Sink Drain: A-SS-01, A-SS-02, A-SS-05

Top Quality Bamboo Cutting Board: A-CB-01



A-SS-01



A-SS-02



A-SS-05



A-CB-01



A-CLDR2

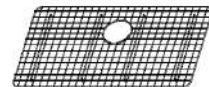

G3S3118

Warranty:

Limited Life Time warranty against manufacturer defects and craftsmanship.