

Specifications:

Installation:	built-in wall mount
Exterior Dimensions:	W: 5 1/8" H: 7 1/4"
Material:	solid brass construction with progressive ceramic cartridge and 1-way diverter cartridge
Water use:	5.0 GPM (43.5 PSI)
Finishes:	CR - polished chrome NI - brushed nickel 44 - matte black
Fittings included:	Rough-in # VPBP1 and trim # 41PBP1.L.O-A
Tile opening max size:	W: 4" H: 5 3/4"



Features:

- unibody pressure balancing progressive valve with 1-way diverter and OFF function
- trim sold separately
- lever handles and oblong backplate
- 1-way diverter valve with 90° rotating angle
- anti-scald protection & temperature regulation for flow rates as low as 1.75 GPM
- screwdriver service stops
- finished wall must be flush with mudguard as marked
- 1/2" Male NPT inlets & outlets, optional sweat connection
- 1" extension kit available



Codes + Standards:

- Meets and exceeds applicable national codes
 - ASME A112.18.1/CSA B125.1
 - ASSE 1016/ASME A112.1016/CSA B125.16
- CAL-Green compliant

ADA compliant when installed to specific requirements of this regulation

Recommended Items:

- Replacement parts:
 - VPBP1 rough-in
 - 41PBP1.L.O-A trim
 - VPBP-C ceramic cartridge
 - VD1-C- diverter cartridge
 - VPBP1-2-EX 1" extension kit

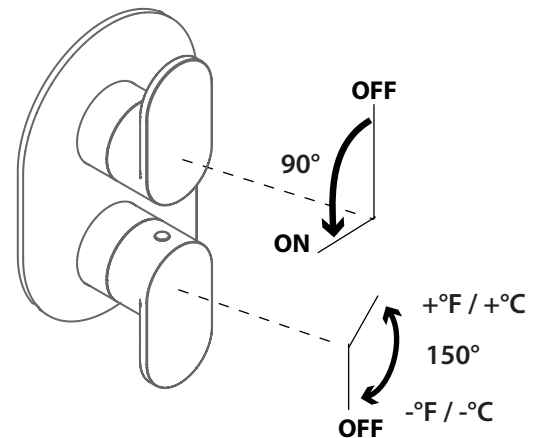

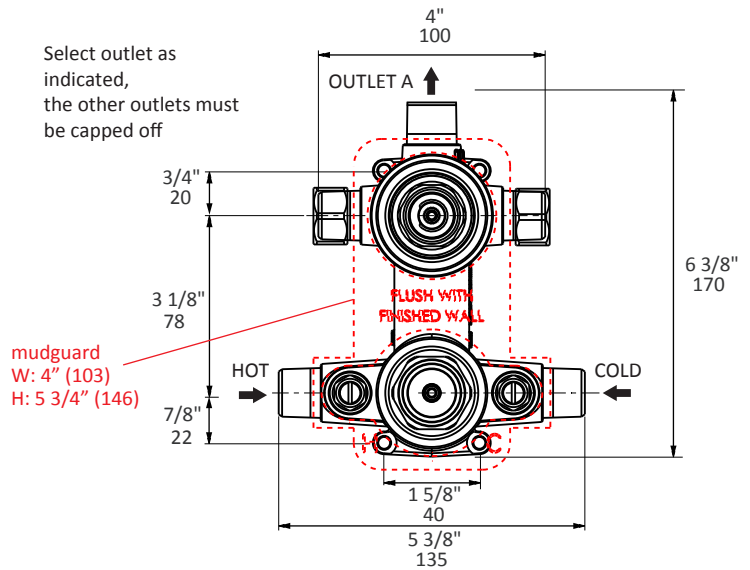
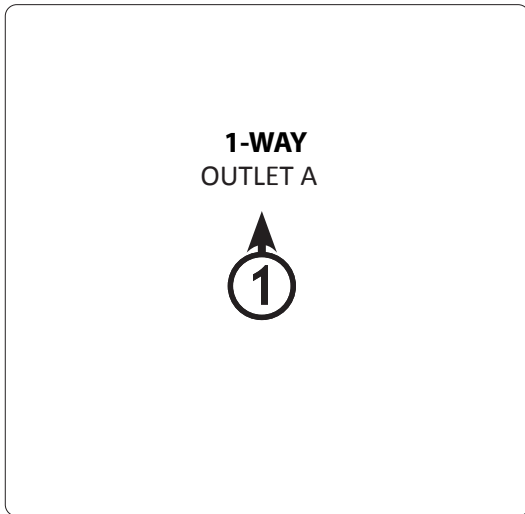

5 X M 1/2 NPT
for 1/2 copper tubing
or for sweat connections

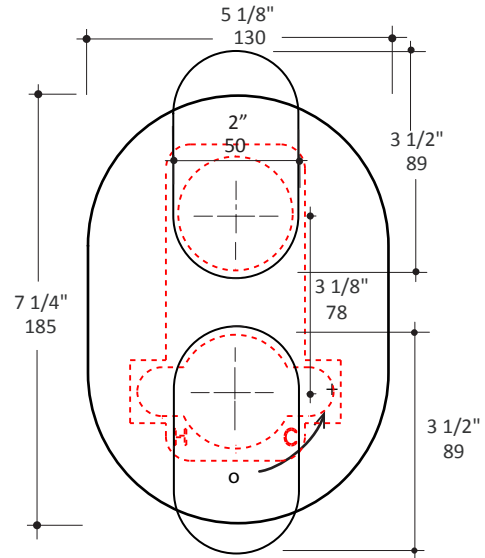
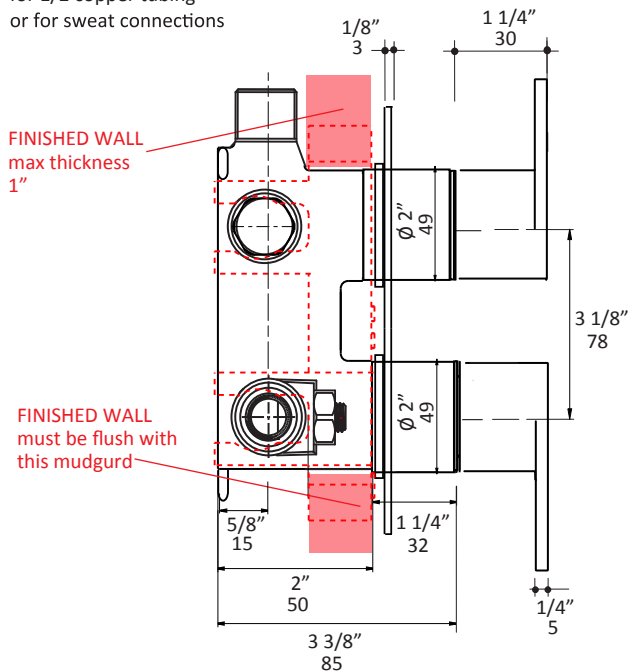

LACAVA reserves the right to revise any dimension or information on this sheet without notice. Dimensions are nominal and may vary within an industry accepted tolerance of 1/4". Drawings provided herein are meant to give the user an idea of the product and are not made to scale. Location of plumbing is meant for reference, your specific application may vary.
Revised: 3/18/2024