

KHU100-32

32 Inch Undermount Single Bowl Stainless Steel Kitchen Sink

Kräus[®]

SPECIFICATION SHEET

Sink Dimensions

Overall Dimensions: 32" x 19"

Bowl Dimensions: 30" x 17"

Sink Depth: 10"

Features

- 16 Gauge Stainless Steel Construction
- Single Bowl Undermount Handmade Sink
- Required Minimum Cabinet Size: 36" Left to Right, 24" Front to Back
- Rear Center-Set Drain
- 3 1/2" Drain Opening
- NoiseDefend Undercoating and Sound Dampening Pads

Accessories Included

- Basket Strainer BST-1
- Bottom Grid KBG-100-32
- Cut-Out Template
- Mounting Hardware
- Towel

CODES/STANDARDS:

Product Certification

cUPC (ASME A112.19.3/CSA B45.4)

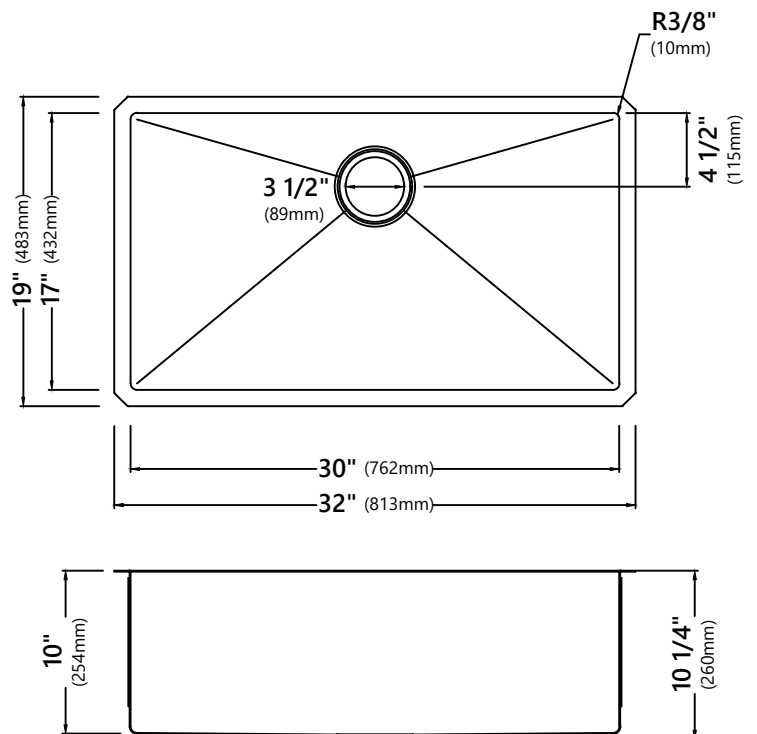

Warranty

Kraus Limited Lifetime Warranty

see website for details www.kraususa.com

KWD100-75

Garbage Disposal

Garbage Disposal Dimensions

Overall Dimensions: 7 1/2" x 10 1/4" x 15 1/4"

Features

- 3/4 Horsepower
- 3800RPM Motor Speed
- Permanent Magnet Motor Type
- 40.6 oz. Grind Chamber Capacity
- Stainless Steel Jam Resistant Grinding System
- Continuous Feed
- Sound Insulated
- Splash Guard
- Sink Stopper
- Anti-Vibration Mount
- Easy Mount System
- Manual Reset Overload
- Connection to Dishwasher
- 1 1/2" Drain Connection

Specifications

- Voltage 110V 60Hz
- Amperage 5A
- On/Off Control Wall Switch

Available Colors

- Black
- White

CODES/STANDARDS:

Product Certification
cUPC, ETL and ISTA certified

Warranty

Kraus Limited 5 Year Warranty
see website for details www.kraususa.com

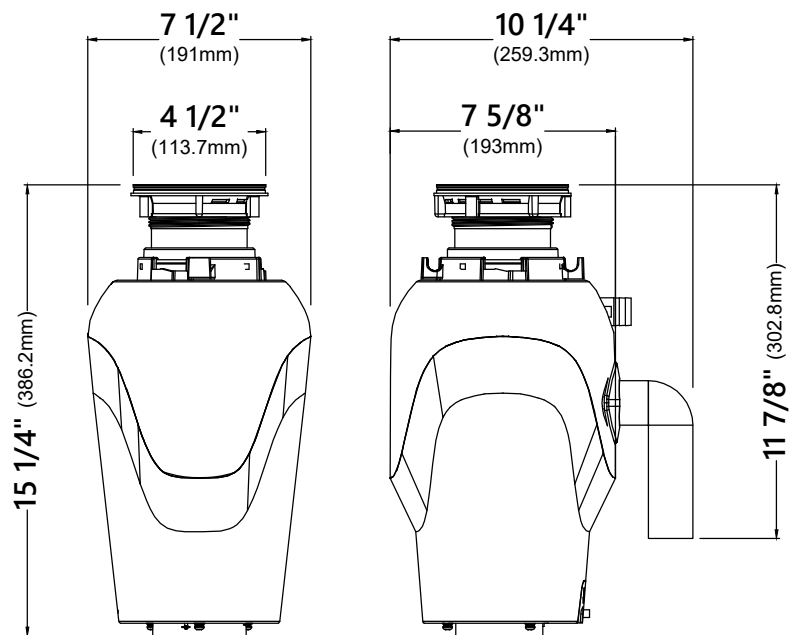

KBG-100-32

Stainless Steel Kitchen Sink Bottom Grid

Grid Dimensions

Overall Dimensions: 29 1/2" x 16 5/8" x 1 1/8"

Features

- Commercial grade stainless steel construction
- For Use with the KHU100-32 kitchen sink
- Protects bottom of sink from daily wear and tear
- Rubber feet provide additional protection

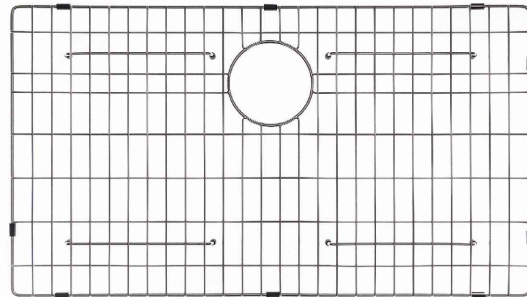

Warranty

Kraus One Year Limited Warranty

see website for details www.kraususa.com

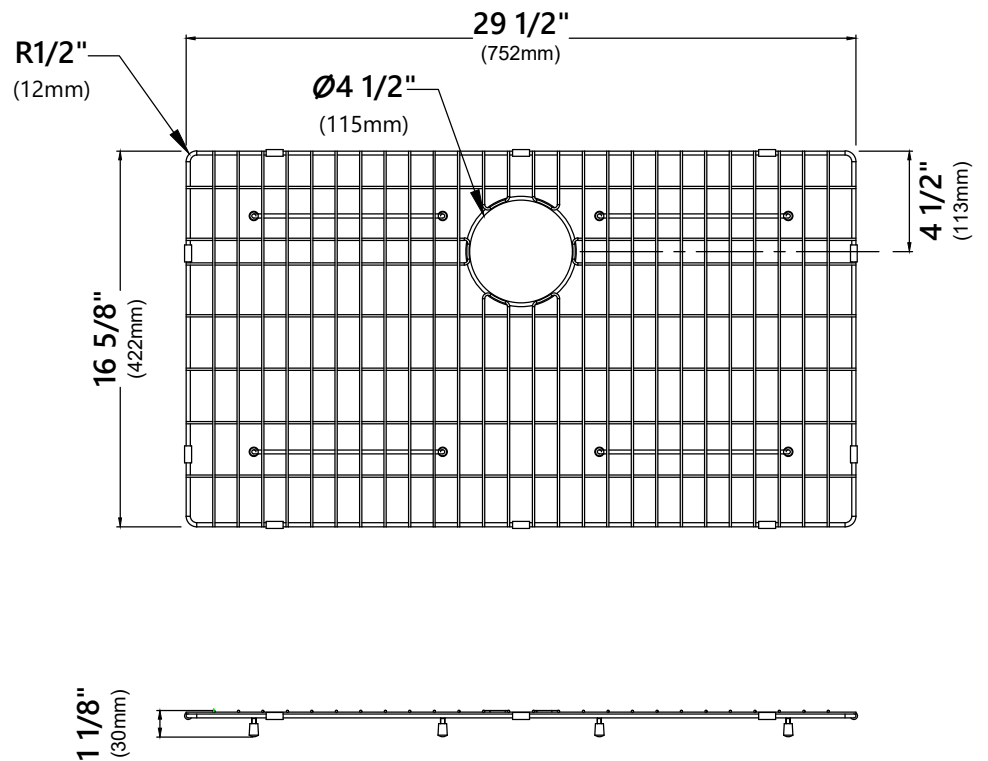

BST-1

Stainless Steel Basket Strainer

Basket Strainer Dimensions

Overall Dimensions: 4 1/2" x 4 1/2"

Features

- Premium Stainless Steel Construction
- Fits Standard 3 1/2" or 4" Drain Openings
- Removable Basket Prevents Debris from Clogging Drain Pipe



Warranty

Kraus 1 Year Limited Warranty

see website for details www.kraususa.com

