



Statement™ | K-CA37599-8L

76" H pivot shower door with 5/16"-thick glass

Features

- Premium stainless steel hinge design allows for effortless opening and closing of the pivot panel
- Controlled Close® innovative soft-close with spring-dampening technology eliminates slamming and brings door to a secure close
- Frameless design emphasizes glass and creates a sleek, minimalist look
- Back-to-back 14-7/16" (367 mm) vertical handles
- Tempered glass ensures enhanced safety and durability
- CleanCoat®+ glass coating creates a hydrophobic barrier that repels water, soap scum, and residue, saving time and protecting shower doors 10 times longer than original CleanCoat. (Based on 2021 internal wear/abrasion testing using a microfiber cloth.)
- SealNetik™ full-length magnetic seal keeps door firmly closed, providing excellent water containment
- Smooth, easy-to-clean wall jams
- Pivot shower door configuration consists of one moving panel and one stationary panel
- Coordinates with other products in the Statement™ collection



Available Colors/Finishes

Color tiles intended for reference only.

- SHP Bright Polished Silver
- BL Matte Black
- 2MB Vibrant Brushed Moderne Brass
- BNK Anodized Brushed Nickel



1-800-4KOHLER (1-800-456-4537)
Kohler Co. reserves the right to make revisions without notice to product specifications.
For the most current specification sheet, go to www.kohler.com USA or www.kohler.ca Canada.
3-27-2026 14:7 - US-CA

THE BOLD LOOK
OF **KOHLER**

Codes/Standards

ANSI Z97.1 (Tempered Glass)
CAN/CGSB-12.1
CPSC 16CFR 1201

Technical Information

All product dimensions are nominal.

Base-To-Wall Radius - Maximum:	1/2" (13 mm)
Shower Ledge Minimum Flat:	2-1/2" (64 mm)
Shower Wall Minimum Flat:	2-1/2" (64 mm)
Weight:	118 lbs (53.5 kg)

Material

- Frameless, heavy 5/16" (8 mm) thick Crystal Clear tempered glass
 - Anodized aluminum prevents rust and corrosion
-

Warranty

See website for detailed warranty information.

KOHLER® Bath and Shower Doors Commercial One-Year Limited
Warranty



1-800-4KOHLER (1-800-456-4537)
Kohler Co. reserves the right to make revisions without notice to product specifications.
For the most current specification sheet, go to www.kohler.com USA or www.kohler.ca Canada.
3-27-2026 14:7 - US-CA

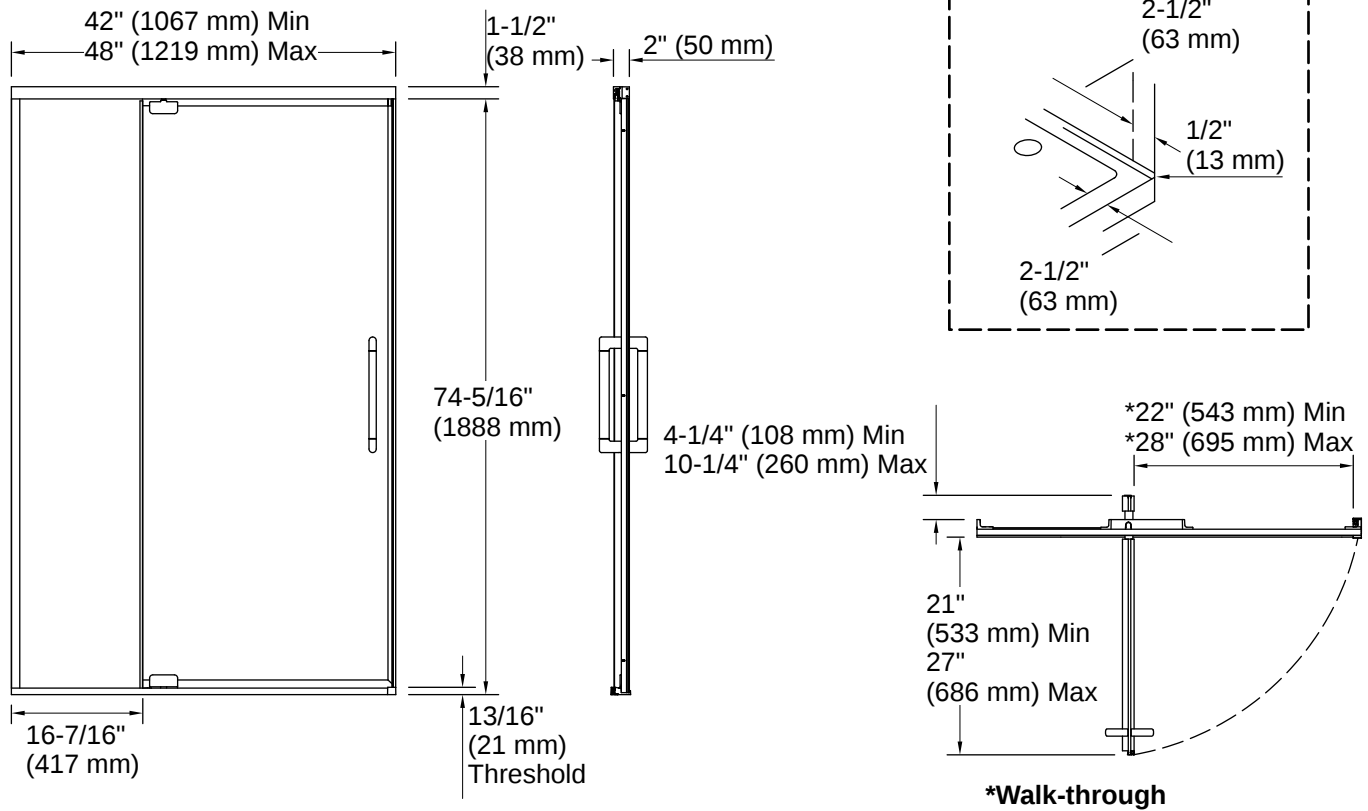

Installation

- Fits opening widths 42" - 48" (1067 -1219 mm)
- 76" (1930 mm) high, with a lofty 74-5/16" (1888 mm) minimum head clearance
- 6" (152 mm) width adjustment
- 3/4" (19 mm) out-of-plumb adjustability on each side simplifies installation
- Door can be installed to open to the left or right to suit your bathroom layout

Installation Notes

Install this product according to the installation instructions.

The vertical opening should be a minimum of 76-3/4" (1949 mm) to allow for installation clearance.

