

### Features

- Designed to fit K-99006-NA and K-99007-NA Verdera medicine cabinets (sold separately).
- Coordinates with Jacquard vanities for a matched ensemble.
- Catalyzed conversion varnish provides a durable moisture-resistant finish.
- Mounts directly to wall for easy installation.

### Material

- Solid wood and veneers.

### Recommended Products/Accessories

K-99007-TL Lighted Medicine Cabinet  
K-99006 Medicine Cabinet  
K-99007-SCF Medicine Cabinet



### Codes/Standards









EPA TSCA Title VI  
CARB P2

### KOHLER® One-Year Limited Warranty

See website for detailed warranty information.

### Available Colors/Finishes

*Color tiles intended for reference only.*

Color	Code	Description
	1WA	Linen White
	1WG	Cherry Tweed
	1WB	Claret Suede
	1WH	Woolen Oak
	1WC	Felt Grey
	1WE	Terry Walnut
	1WT	Mohair Grey
	1WU	Batiste Black

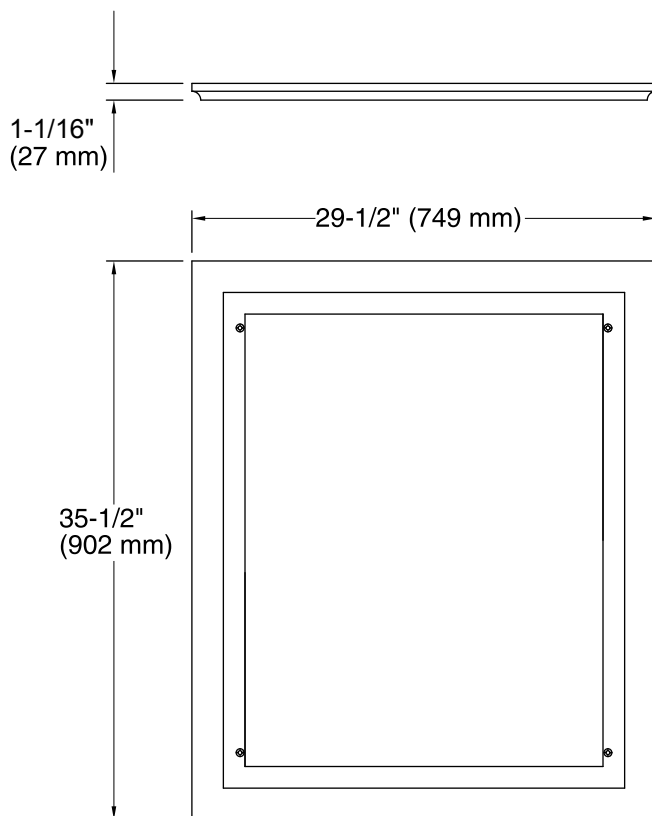

### Technical Information

All product dimensions are nominal.

### Notes

Install this product according to the installation guide.