

Features

- Catalyzed conversion varnish provides a durable moisture-resistant finish.
- Two doors and six drawers.
- Frameless construction with full-overlay doors and drawers.
- Three-way adjustable slow-close door hinges with 110-degree opening capability for easy cabinet access.
- Full-extension 18-inch depth drawers with slow-close under-mount slides for smooth opening.
- Solid wood drawers with dovetail construction.
- Legs offer the polished look of furniture in the bath.
- Coordinates with the K-99686 Damask knob and K-99689 Damask handle (sold separately).
- Combines with Ceramic/Impressions®, Solid/Expressions™, and Iron/Impressions™ vanity tops (sold separately) for a complete vanity.
- Customize your storage with optional in-door accessories, in-drawer accessories, and medicine cabinet surrounds and side kits (sold separately).

Material

- Solid wood and veneers.
- Wood is a living material, and its beauty is enhanced by natural variations in grain, color, and pattern. No two pieces of wood are exactly the same, and the color will change with age, temperature, and exposure to light.
- The nature of wood grain can cause variations in stain depth. Our expert craftspeople hand-apply the stain to blend these variations.

Recommended Products/Accessories

K-5459 Bathroom Vanity Top
K-5441 Bathroom Vanity Top
K-2893-1 Vitreous Top and Basin Bathroom Sink
K-2893-8 Vitreous Top and Basin Bathroom Sink
K-99686 Knob
K-99689 Handle

Optional Products/Accessories

K-99665 Framed Mirror
K-99681 Side Mount Electrical Outlets
K-99682 General Storage
K-99683 Makeup Storage
K-99684 Drawer Dividers
K-99672 Two-Drawer Bridge
K-99668 Lap Drawer
K-99676 Filler Strip
K-99001 Medicine Cabinet
K-99007 Medicine Cabinet
K-99009 Medicine Cabinet



Codes/Standards









EPA TSCA Title VI
CARB P2

KOHLER® One-Year Limited Warranty

See website for detailed warranty information.

Available Colors/Finishes

Color tiles intended for reference only.

Color	Code	Description
	1WA	Linen White
	1WG	Cherry Tweed
	1WB	Claret Suede
	1WH	Woolen Oak
	1WC	Felt Grey
	1WE	Terry Walnut
	1WT	Mohair Grey
	1WU	Batiste Black

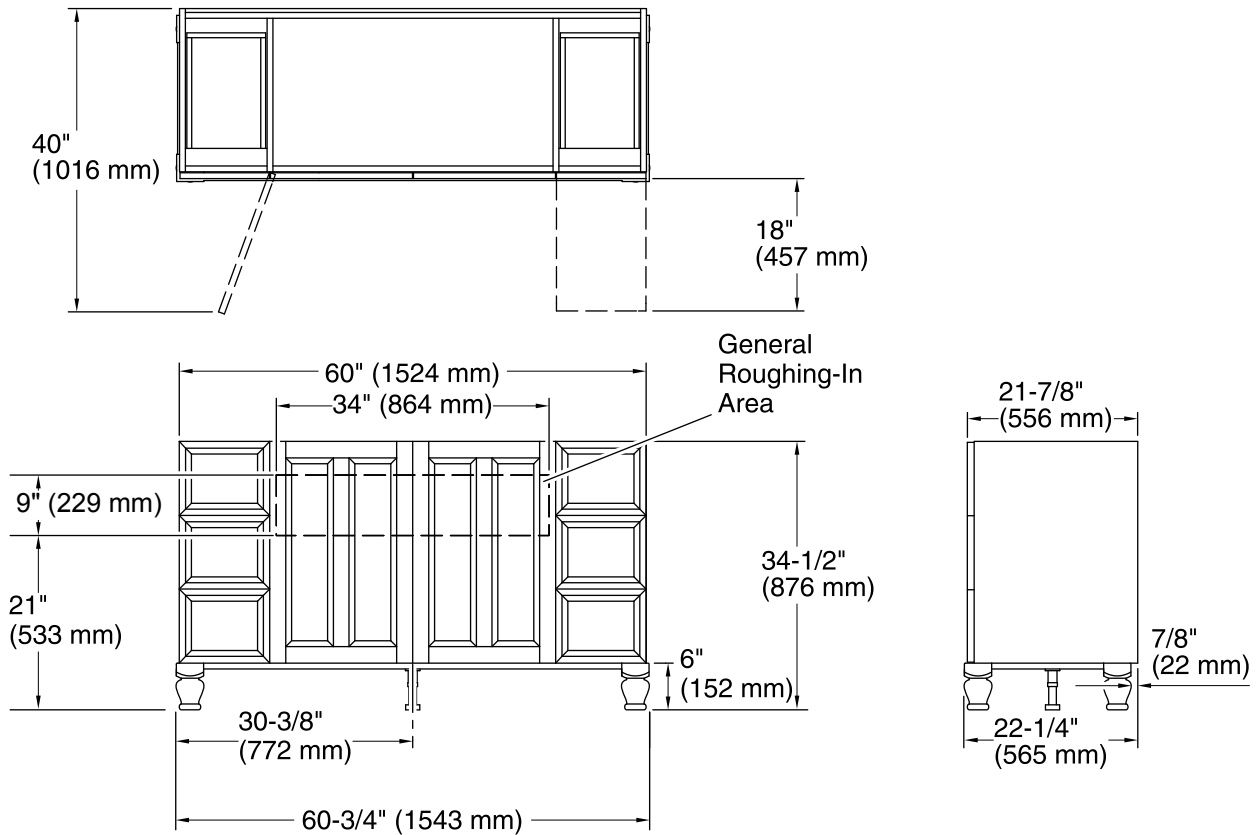

Technical Information

All product dimensions are nominal.

Vanity type: Standard

Notes

Install this product according to the installation guide.

Decorative cabinet hardware is not supplied. Refer to the KOHLER bath accessories line for recommended cabinet hardware to complement your vanity.

Select the type of fastener based upon the wall material. Two 250 lb (113.4 kg) minimum load bearing fasteners are recommended.