

Features

- Premium metal construction for durability.
- KOHLER finishes resist corrosion and tarnish.
- Includes tempered-glass shelf.
- Required for one-piece Sonata shower stalls, except K-1569.



Codes/Standards









ASTM F446

KOHLER® One-Year Limited Warranty

See website for detailed warranty information.

Available Colors/Finishes

Color tiles intended for reference only.

Color	Code	Description
	CP	Polished Chrome
	SN	Vibrant® Polished Nickel
	AF	Vibrant® French Gold
	PB	Vibrant® Polished Brass
	G	Brushed Chrome
	BN	Vibrant® Brushed Nickel
	BV	Vibrant® Brushed Bronze
	2BZ	Oil-Rubbed Bronze
	VNT	Vintage Nickel

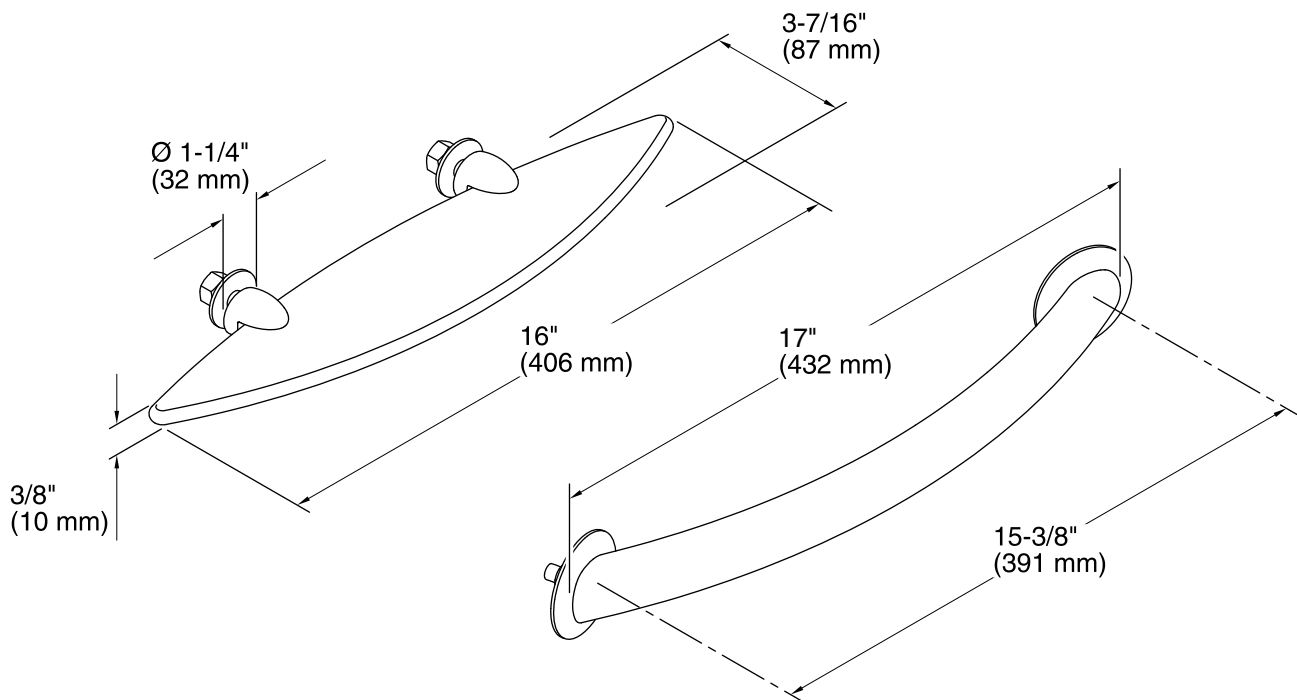

Technical Information

All product dimensions are nominal.

Material: Glass, Metal