

Features

- 6 hydromassage jets can be individually adjusted for water flow and direction.
- Variable-speed pump for adjusting massage intensity.
- Adjustable neckjet pillow with 2 jets provides a stimulating, stress-relieving neck massage.
- Built-in heater.
- Electronic keypad.
- Generous 6-foot length provides spacious bathing for up to two people.
- Molded armrests offer extra comfort while bathing.
- Safeguard® slip-resistant surface on bath floor.

Material

- KOHLER® enameled cast iron.

Hydrotherapy

- Whirlpool
- Neckjets

Installation

- Drop-in or three-wall alcove.

Additional Hydrotherapy Options

- Soaking Bath - K-863-0
- BubbleMassage air bath - K-865-G0
- Whirlpool - K-865-H2
- Whirlpool + neck jets - K-865-N1

Required Products/Accessories

K-7169-AF 1-1/2" Contoured Pop-up Drain
K-9696 Whirlpool 6-Jet Trim Kit

Recommended Products/Accessories

K-1179 Vinyl Tiling-in Bead
K-582 Under-Mount Installation Kit
K-1705 Whirlpool/BubbleMassage™ Remote Control
K-9498 3" Keypad Trim



Codes/Standards

ASME A112.19.1/CSA B45.2
ASME A112.19.7/CSA B45.10
ASTM F462
UL 1795
CSA C22.2 No. 218.2











KOHLER® Enameled Cast Iron Bath and Shower Base Lifetime Limited Warranty

KOHLER® Hydrotherapy Components Five-Year Limited Warranty

See website for detailed warranty information.

Available Colors/Finishes

Color tiles intended for reference only.

| Color | Code | Description |
|--------------------------------------------------------------------------------------|------|---------------|
|  | 0 | White |
|  | 96 | Biscuit |
|  | 47 | Almond |
|  | NY | Dune |
|  | 95 | Ice™ Grey |
|  | G9 | Sandbar |
|  | 33 | Mexican Sand™ |
|  | K4 | Cashmere |
|  | 58 | Thunder™ Grey |
|  | 7 | Black Black™ |

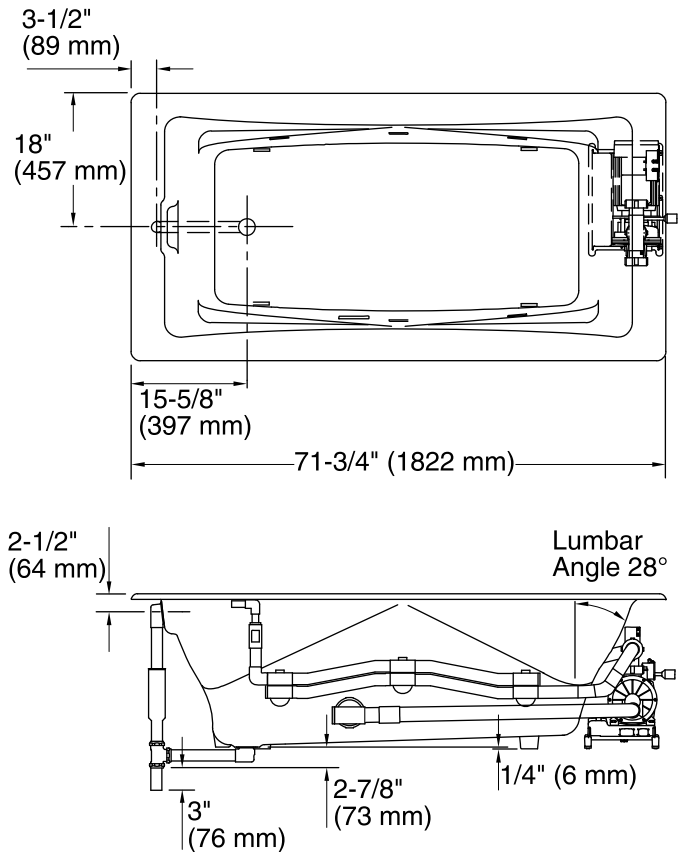

No change in measurements if connected with drain illustrated. (K-7169-AF)

Pump/Control Access
34" (864 mm) W x 15" (381 mm) H

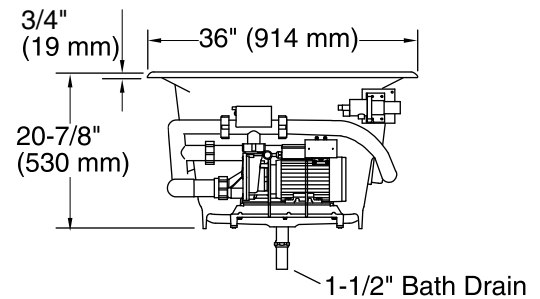

Required Electrical Service

One dedicated circuit required, protected with Class A Ground-Fault Circuit-Interrupter (GFCI). Outside North America, this device may be known as a Residual Current Device (RCD).

Pump, Heater: 240 V, 20 A, 50/60 Hz

Technical Information

All product dimensions are nominal.

| | |
|------------------------------|---------------------------------------------------|
| Installation: | Drop-in, Three-wall alcove |
| Drain location: | End |
| Basin area, bottom: | 49" x 22" (1245 mm x 559 mm) |
| Basin area, top: | 62" x 28" (1575 mm x 711 mm) |
| Weight: | 455 lbs (206.4 kg) |
| Minimum floor load: | 69 lbs/ft ² (336.9 kg/m ²) |
| Water depth: | 17" (432 mm) |
| Water capacity: | 89 gal (336.9 L) |
| Cutout: | Drop-in, 70-1/4" x 34-1/2" (1784 mm x 876 mm) |
| Electrical component rating: | Pump: 240 V, 11 A Heater: 240 V, 6 A, 1500 W |
| Pump speed: | Variable |
| Minimum flat for door: | 2-1/4" (57 mm) |

Notes

Measure your actual product for rough-in details. Install this product according to the installation instructions.

The hot water supply should be 70% of the capacity of the bath or greater. Installations will vary.

Kit is required for under-mount installations (sold separately).

Cast iron whirlpools are extremely heavy, making some drop-in installations difficult. Splitting the deck/surround is recommended if installing into a deck.