

Features

- 6 hydromassage jets can be individually adjusted for water flow and direction.
- Variable-speed pump for adjusting massage intensity.
- Built-in heater.
- Electronic keypad.
- Generous 6-foot length provides spacious bathing for up to two people.
- Molded armrests offer extra comfort while bathing.
- Safeguard® slip-resistant surface on bath floor.
- Multiple pump location options give you more choices for installation and access. (See specification sheet for pump locations.)
- End drain.
- Under-mountable

Material

- KOHLER® enameled cast iron.

Hydrotherapy

- Whirlpool

Installation

- Drop-in, under-mount, or three-wall alcove.

Required Products/Accessories

K-7169-AF 1-1/2" Contoured Pop-up Drain
K-9696 Whirlpool 6-Jet Trim Kit

Recommended Products/Accessories

K-1179 Vinyl Tiling-in Bead
K-582 Under-Mount Installation Kit
K-9498 3" Keypad Trim



Codes/Standards

ASME A112.19.1/CSA B45.2
ASME A112.19.7/CSA B45.10
ASTM F462
UL 1795
CSA C22.2 No. 218.2











KOHLER® Enameled Cast Iron Bath and Shower Base Lifetime Limited Warranty

KOHLER® Hydrotherapy Components Five-Year Limited Warranty

See website for detailed warranty information.

Available Colors/Finishes

Color tiles intended for reference only.

Color	Code	Description
	0	White
	96	Biscuit
	47	Almond
	NY	Dune
	95	Ice™ Grey
	G9	Sandbar
	33	Mexican Sand™
	K4	Cashmere
	58	Thunder™ Grey
	7	Black Black™

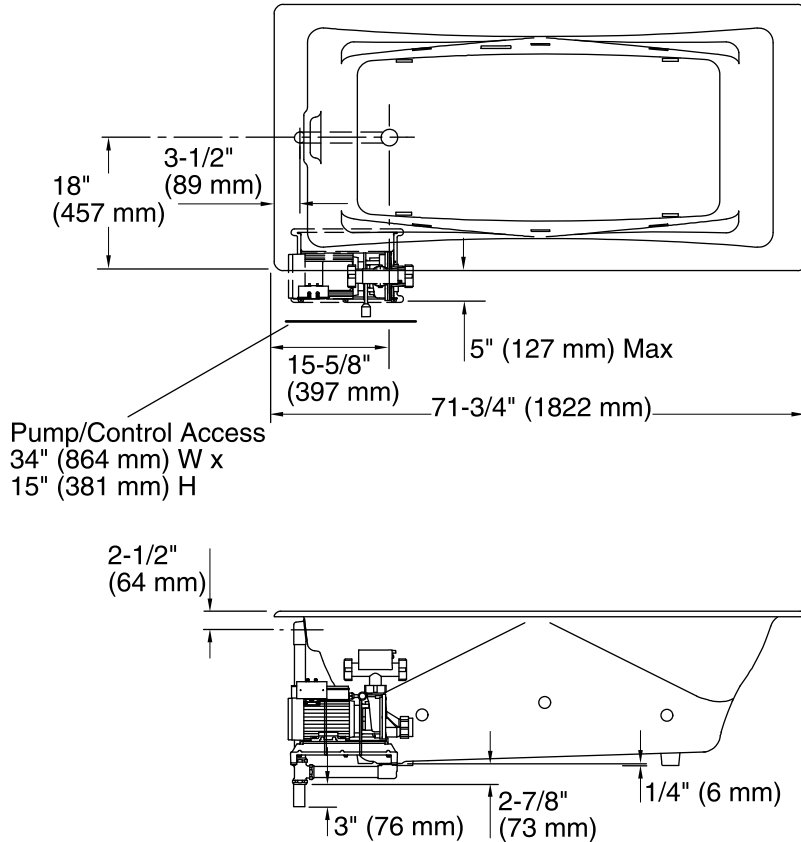

No change in measurements if connected with drain illustrated. (K-7169-AF)

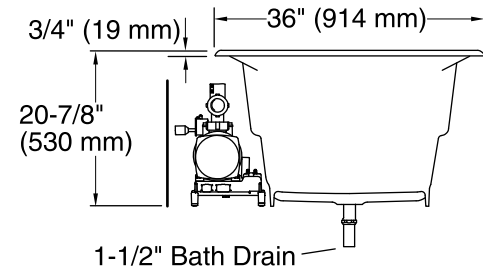

Required Electrical Service

One dedicated circuit required, protected with Class A Ground-Fault Circuit-Interrupter (GFCI). Outside North America, this device may be known as a Residual Current Device (RCD).

Pump, Heater: 240 V, 20 A, 50/60 Hz

Technical Information

All product dimensions are nominal.

Installation:	Drop-in, Under-mount, Three-wall alcove
Drain location:	End
Basin area, bottom:	49" x 22" (1245 mm x 559 mm)
Basin area, top:	62" x 28" (1575 mm x 711 mm)
Weight:	455 lbs (206.4 kg)
Minimum floor load:	69 lbs/ft ² (336.9 kg/m ²)
Water depth:	17" (432 mm)
Water capacity:	89 gal (336.9 L)
Cutout:	Drop-in, 70-1/4" x 34-1/2" (1784 mm x 876 mm)
Template:	Under-mount, K-582, required, not included
Electrical component rating:	Pump: 240 V, 11 A Heater: 240 V, 6 A, 1500 W

Notes

Measure your actual product for rough-in details. Install this product according to the installation instructions.

The hot water supply should be 70% of the capacity of the bath or greater. Installations will vary.

Pump must be relocated to custom position at the time of installation. Provide adequate clearance.

Kit is required for under-mount installations (sold separately).

Cast iron whirlpools are extremely heavy, making some drop-in installations difficult. Splitting the deck/surround is recommended if installing into a deck.