

Features

- 8 hydromassage jets can be individually adjusted for water flow and direction.
- Variable-speed pump for adjusting massage intensity.
- Built-in heater.
- Electronic keypad.
- Spacious design accommodates up to two bathers.
- Safeguard slip-resistant surface on bath floor.
- Right-hand drain.
- Under-mountable

Material

- KOHLER® enameled cast iron.

Hydrotherapy

- Whirlpool

Installation

- Three-wall alcove.

Additional Hydrotherapy Options

- Soaking Bath - K-855-R
- Whirlpool - K-856-RH

Required Products/Accessories

K-7147-AF 1-1/2" Contoured Pop-up Drain
K-9698 Flexjet® Whirlpool Trim Kit



Codes/Standards

ASME A112.19.1/CSA B45.2
ASME A112.19.7/CSA B45.10
ASTM F462
UL 1795
CSA C22.2 No. 218.2











KOHLER® Enameled Cast Iron Bath and Shower Base Lifetime Limited Warranty

KOHLER® Hydrotherapy Components Five-Year Limited Warranty

See website for detailed warranty information.

Available Colors/Finishes

Color tiles intended for reference only.

Color	Code	Description
	0	White
	96	Biscuit
	47	Almond
	NY	Dune
	95	Ice™ Grey
	G9	Sandbar
	33	Mexican Sand™
	K4	Cashmere
	58	Thunder™ Grey
	7	Black Black™

No change in measurements if connected with drain illustrated. (K-7147-AF)

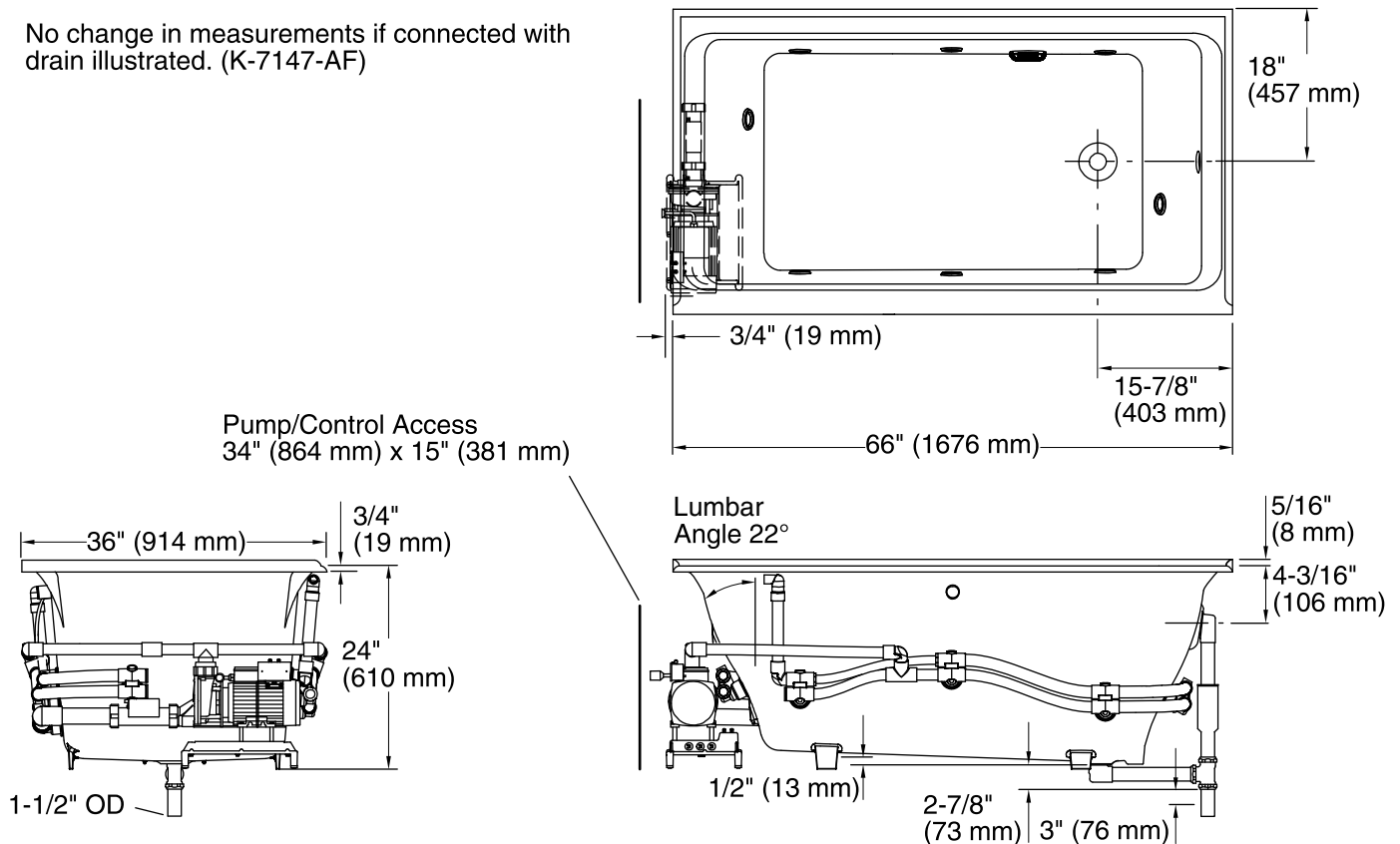

Required Electrical Service

One dedicated circuit required, protected with Class A Ground-Fault Circuit-Interrupter (GFCI). Outside North America, this device may be known as a Residual Current Device (RCD).

Pump: 240 V, 20 A, 50/60 Hz

Technical Information

All product dimensions are nominal.

Installation:	Three-wall alcove
Drain location:	Right
Basin area, bottom:	45" x 25" (1143 mm x 635 mm)
Basin area, top:	58" x 29" (1473 mm x 737 mm)
Weight:	510 lbs (231.3 kg)
Minimum floor load:	86 lbs/ft ² (419.9 kg/m ²)
Water depth:	19-1/2" (495 mm)
Water capacity:	105 gal (397.5 L)
Electrical component rating:	Pump: 240 V, 11 A, 1500 W
Pump speed:	Variable
Minimum flat for door:	1-13/16" (46 mm)

Notes

Measure your actual product for rough-in details. Install this product according to the installation instructions.

The hot water supply should be 70% of the capacity of the bath or greater. Installations will vary.

Cast iron whirlpools are extremely heavy, making some drop-in installations difficult. Splitting the deck/surround is recommended if installing into a deck.