

### Features

- 44 airjets release thousands of bubbles that surround, support, and massage the body.
- Variable-speed blower lets you adjust massage intensity to 18 levels.
- Zones of Control feature allows you to target massage to back, midsection, or feet.
- Electronic keypad.
- Spacious design accommodates up to two bathers.
- Safeguard® slip-resistant surface on bath floor.
- Immediate and manual purge cycles remove residual water from air channels after use
- Under-mountable

### Material

- KOHLER® enameled cast iron.

### Hydrotherapy

- BubbleMassage

### Installation

- Drop-in or under-mount.

### Required Products/Accessories

K-7147-AF 1-1/2" Contoured Pop-up Drain

### Recommended Products/Accessories

K-1705 Whirlpool/BubbleMassage™ Remote Control  
K-587 Under-Mount Installation Kit  
K-9498 3" Keypad Trim  
K-1179 Vinyl Tiling-in Bead



### Codes/Standards

ASME A112.19.1/CSA B45.2  
ASME A112.19.7/CSA B45.10  
ASTM F462  
UL 1795  
CSA C22.2 No. 218.2







### KOHLER® Enameled Cast Iron Bath and Shower Base Lifetime Limited Warranty

### KOHLER® Hydrotherapy Components Five-Year Limited Warranty

See website for detailed warranty information.

### Available Colors/Finishes

*Color tiles intended for reference only.*

Color	Code	Description
	0	White
	96	Biscuit
	47	Almond
	NY	Dune
	G9	Sandbar
	K4	Cashmere
	7	Black Black™

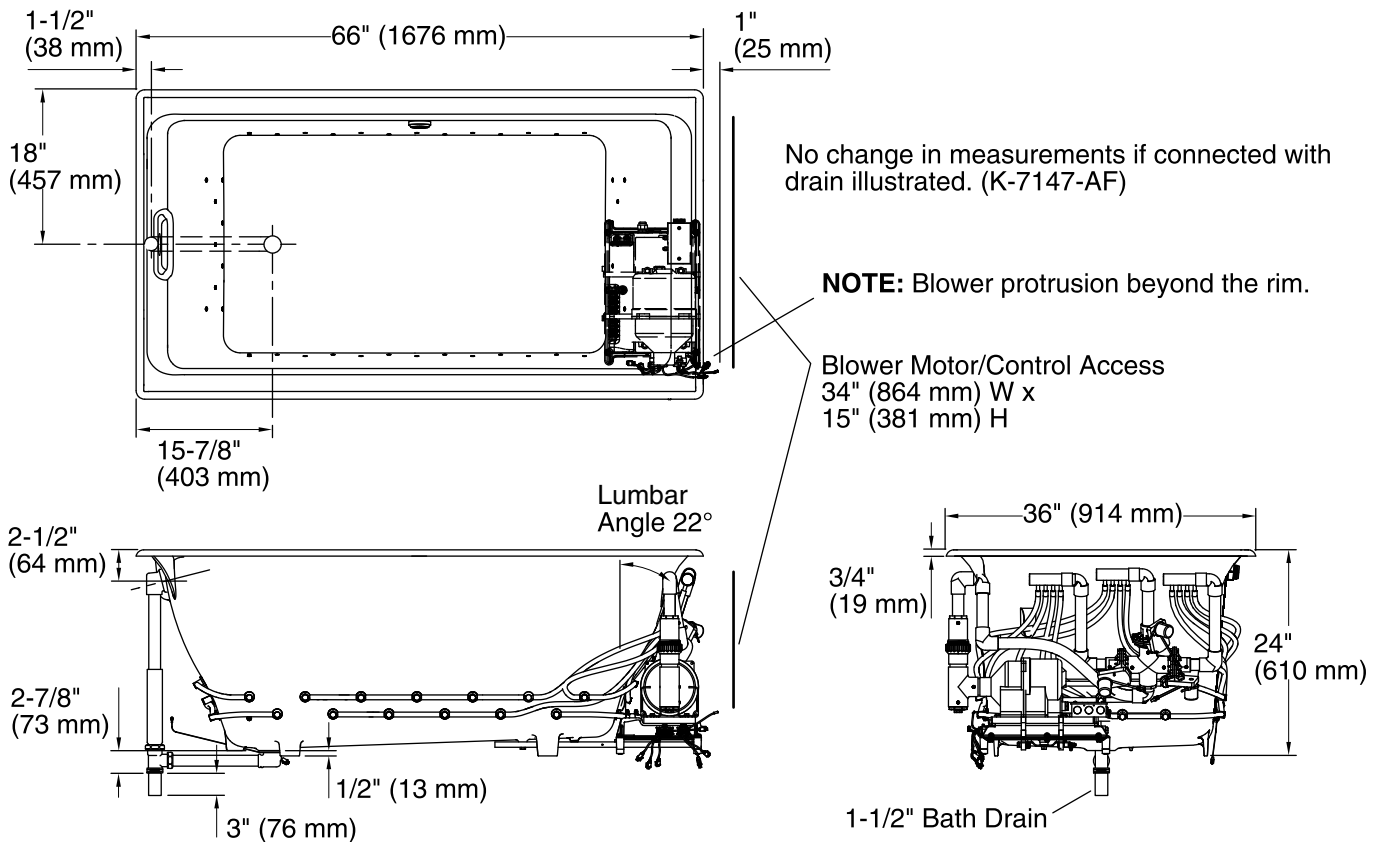

### Required Electrical Service

One dedicated circuit required, protected with Class A Ground-Fault Circuit-Interrupter (GFCI). Outside North America, this device may be known as a Residual Current Device (RCD).

Blower: 240 V, 15 A, 50/60 Hz

### Technical Information

All product dimensions are nominal.

Installation:	Drop-in, Under-mount
Drain location:	End
Basin area, bottom:	45" x 25" (1143 mm x 635 mm)
Basin area, top:	58" x 29" (1473 mm x 737 mm)
Weight:	510 lbs (231.3 kg)
Minimum floor load:	86 lbs/ft <sup>2</sup> (419.9 kg/m <sup>2</sup> )
Water depth:	19-1/2" (495 mm)
Water capacity:	105 gal (397.5 L)
Cutout:	Drop-in, 64-1/2" x 34-1/2" (1638 mm x 876 mm)
Template:	Under-mount, K-587, required, not included
Electrical component rating:	Blower: 240 V, 5 A, 50/60 Hz

### Notes

Measure your actual product for rough-in details. Install this product according to the installation instructions.

The hot water supply should be 70% of the capacity of the bath or greater. Installations will vary.

Kit is required for under-mount installations (sold separately).

If relocating the blower motor, do not relocate or alter the PVC tee or coiled flexible tubing connected to the blower. Follow the blower relocation instructions exactly. Provide access for servicing the blower.