

Features

- 44 airjets release thousands of bubbles that surround, support, and massage the body.
- Variable-speed blower lets you adjust massage intensity to 18 levels.
- Zones of Control feature allows you to target massage to back, midsection, or feet.
- Electronic keypad.
- Safeguard® slip-resistant surface on bath floor.
- Immediate and manual purge cycles remove residual water from air channels after use.
- Under-mountable

Material

- KOHLER® enameled cast iron.

Hydrotherapy

- BubbleMassage

Installation

- Drop-in or under-mount.

Required Products/Accessories

K-7169-AF 1-1/2" Contoured Pop-up Drain

Recommended Products/Accessories

K-1172 Adjustable feet
K-1491 Bath/Whirlpool Pillow
K-1601 Bath/Whirlpool Footstop
K-1705 Whirlpool/BubbleMassage™ Remote Control
K-586 Under-Mount Installation Kit
K-9498 3" Keypad Trim
K-1179 Vinyl Tiling-in Bead



ADA

Codes/Standards

ASME A112.19.1/CSA B45.2
ASME A112.19.7/CSA B45.10
ASTM F462
UL 1795
CSA C22.2 No. 218.2
ADA
ICC/ANSI A117.1

**KOHLER® Enameled Cast Iron Bath
and Shower Base Lifetime Limited
Warranty**







**KOHLER® Hydrotherapy Components
Five-Year Limited Warranty**

See website for detailed warranty information.

Available Colors/Finishes

Color tiles intended for reference only.

Color Code Description

	0	White
	96	Biscuit
	47	Almond
	NY	Dune
	G9	Sandbar
	K4	Cashmere
	7	Black Black™

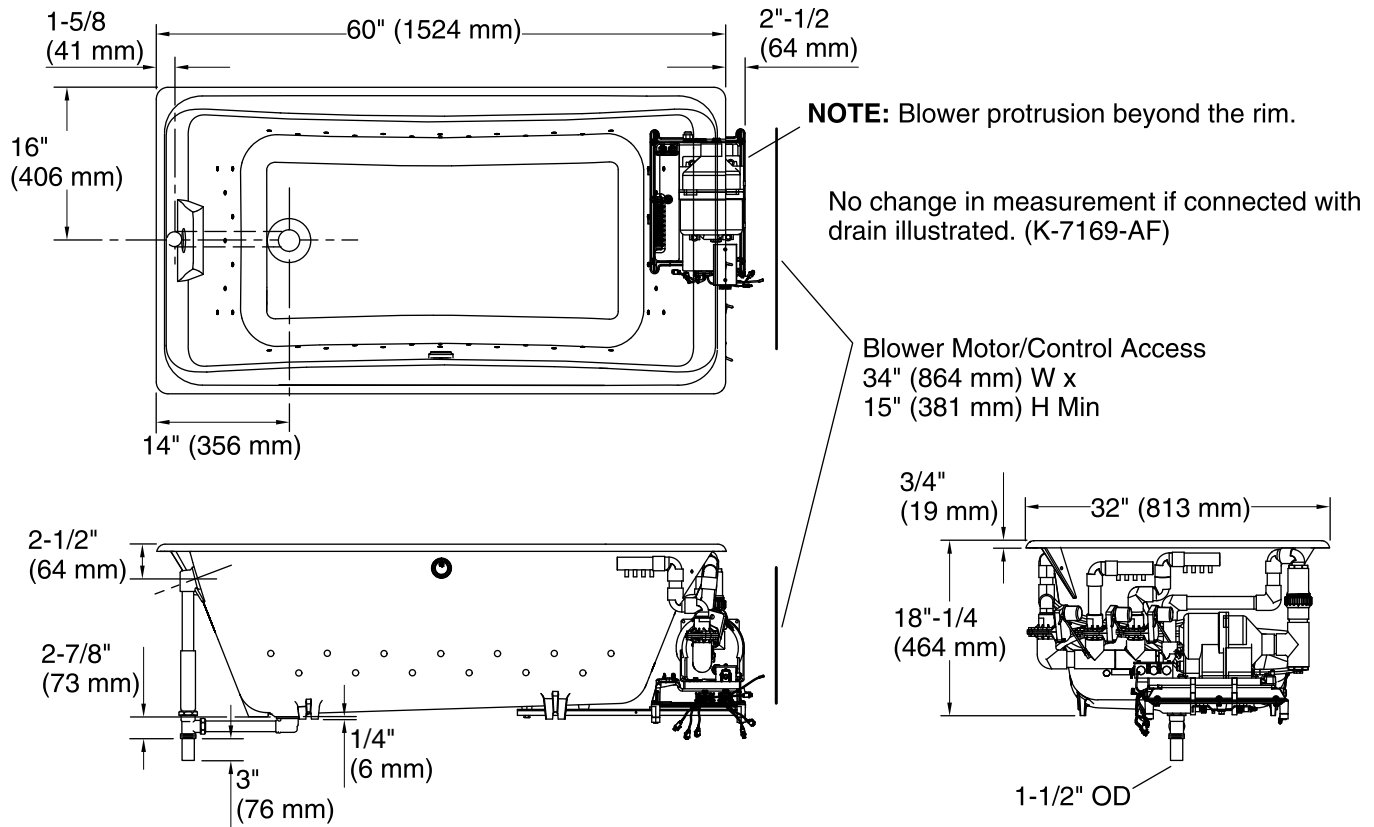

Required Electrical Service

One dedicated circuit required, protected with Class A Ground-Fault Circuit-Interrupter (GFCI). Outside North America, this device may be known as a Residual Current Device (RCD).

Blower: 240 V, 15 A, 50/60 Hz

Technical Information

All product dimensions are nominal.

Installation:	Drop-in, Under-mount
Drain location:	End
Basin area, bottom:	40-1/2" x 20" (1029 mm x 508 mm)
Basin area, top:	52-3/4" x 24" (1340 mm x 610 mm)
Weight:	350 lbs (158.8 kg)
Minimum floor load:	60 lbs/ft ² (292.9 kg/m ²)
Water depth:	13-5/8" (346 mm)
Water capacity:	60 gal (227.1 L)
Cutout:	Drop-in, 58-1/2" x 30-1/2" (1486 mm x 775 mm)
Template:	Under-mount, K-586, required, not included
Electrical component rating:	Blower: 240 V, 5 A, 50/60 Hz

Notes

Measure your actual product for rough-in details. Install this product according to the installation instructions.

The hot water supply should be 70% of the capacity of the bath or greater. Installations will vary.

Kit is required for under-mount installations (sold separately).

If relocating the blower motor, do not relocate or alter the PVC tee or coiled flexible tubing connected to the blower. Follow the blower relocation instructions exactly. Provide access for servicing the blower.

ADA compliant when installed to the specific requirements of these regulations.