

Features

- 18-inch minimum base cabinet.
- Single bowl.
- 9-1/2-inch depth provides generous workspace.
- No faucet holes.
- Includes K-5658 bottom sink rack.
- Includes cutout templates and installation clips.

Material

- KOHLER Neoroc® composite is durable and built to withstand day-to-day cleaning tasks.
- Matte finish offers rich, dimensional color.
- Solid color throughout the sink.
- Heat resistant up to 750°F.
- Scratch, stain, chip, and thermal-shock resistant.

Installation

- Undermount.
- Easy to install in a one-person, single-day project.

Recommended Products/Accessories

K-8801 Sink Strainer
K-8799 Sink Strainer
K-23726 Drain treatment
K-23730 Neoroc® cleaner

Optional Products/Accessories

K-11352 Disposal Flange with Stopper
K-9000 P-Trap

Included Components

Additional Components:
K-5658



ADA

Codes/Standards









CSA B45.5/IAPMO Z124
ADA
ICC/ANSI A117.1

KOHLER® Neoroc® Sinks Lifetime Limited Warranty

See website for detailed warranty information.

Available Colors/Finishes

Color tiles intended for reference only.

Color	Code	Description
	CM6	Matte White
	CM7	Matte Graphite
	CM5	Matte Beige
	CM8	Matte Black Plum
	CM1	Matte Black
	CM2	Matte Brown
	CM3	Matte Toupe
	CM4	Matte Grey

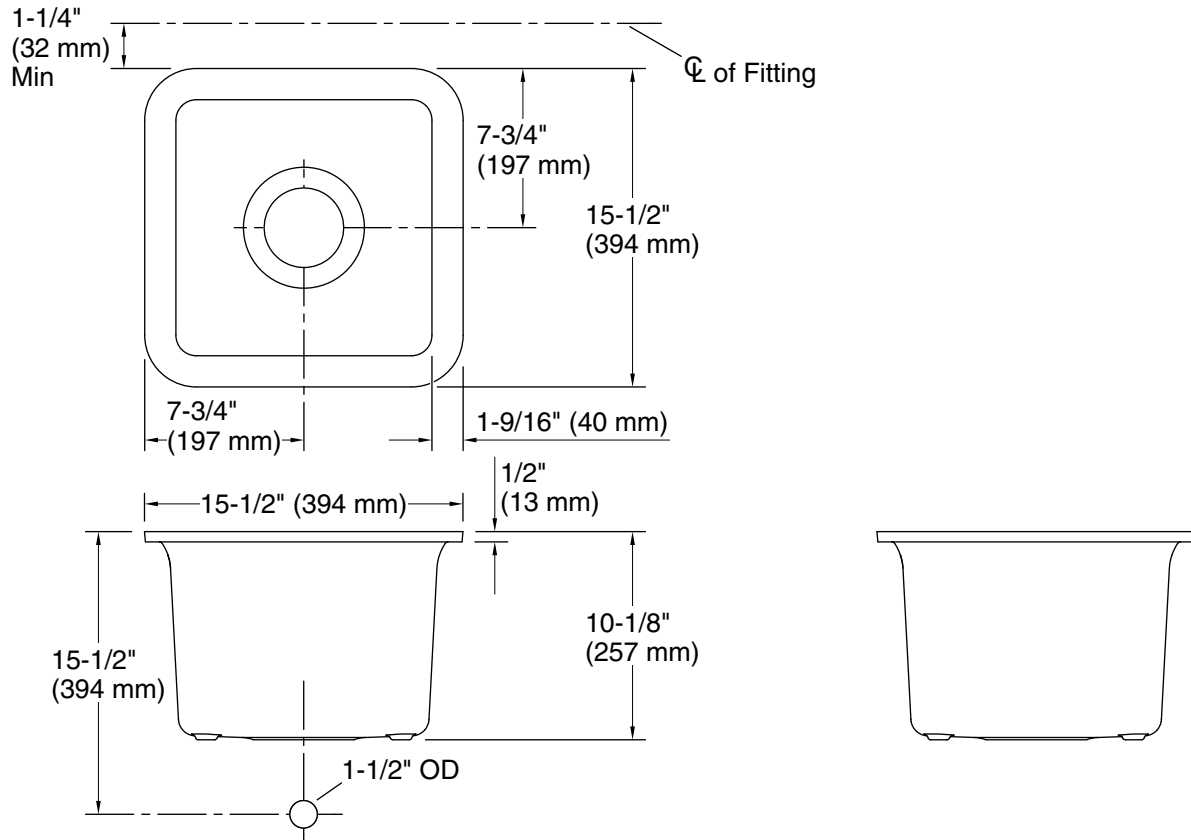

Technical Information

All product dimensions are nominal.

Installation:	Under-mount
Bowl area:	Length: 13-9/16" (344 mm) Width: 13-9/16" (344 mm) Bowl depth: 9-1/2" (241 mm) Water depth: 9-1/2" (241 mm)
Template:	1257826-7, required, included

Notes

Install this product according to the installation instructions.

ADA compliant when installed to the specific requirements of these regulations.

ADA permits a parallel approach to wet bars.