

Features

- Lavatory system with backsplash offers contemporary styling for commercial applications
- Basin and trough slope design prevents water from splashing back on user
- Back ledge provides a dry space for storing cell phones and other devices
- Faucet and soap dispenser attach to lavatory backsplash, eliminating the need to drill through finished wall
- Predrilled mounting holes for faucet and soap dispenser
- Drain strainer helps prevent debris from entering drain
- Lavatory system available in your choice of Silestone® quartz or Corian® Solid Surface in a host of color options
- Silestone® quartz provides exceptional durability and stain resistance, making it easy to maintain
- Corian® Solid Surface has a nonporous surface to help prevent bacteria and mold growth
- Vandal-resistant locking door on stainless steel shroud conceals pipes and swings open to provide easy below-deck access for maintenance
- Requires select Composed® wall-mount faucet and soap dispenser bundles (sold separately)

Installation

- Wall-mount

Recommended Products/Accessories

K-181024-BC1 Touchless lavatory faucet & soap dispenser with Kinesis® sensor technology, AC-powered, 0.5 gpm



ADA

CSA B651

Codes/Standards

IAPMO IGC 156

ADA

ICC/ANSI A117.1















CSA B651

KOHLER® One-Year Limited Warranty

See website for detailed warranty information.

Available Colors/Finishes

Color tiles intended for reference only.

Color	Code	Description
	KEB	Et Bianco Cal
	KEP	Pearl Jasmine
	KEW	Iconic White
	KCC	Canvas
	KEH	Miami White
	KEG	Et Cal Gold
	KED	Desert Silver
	KES	Et Statuario
	KCE	Ash Concrete
	KCD	Designer White
	KCG	Glacier White
	KCT	Concrete
	KCR	Arrow Root
	KCN	Neutral Concrete

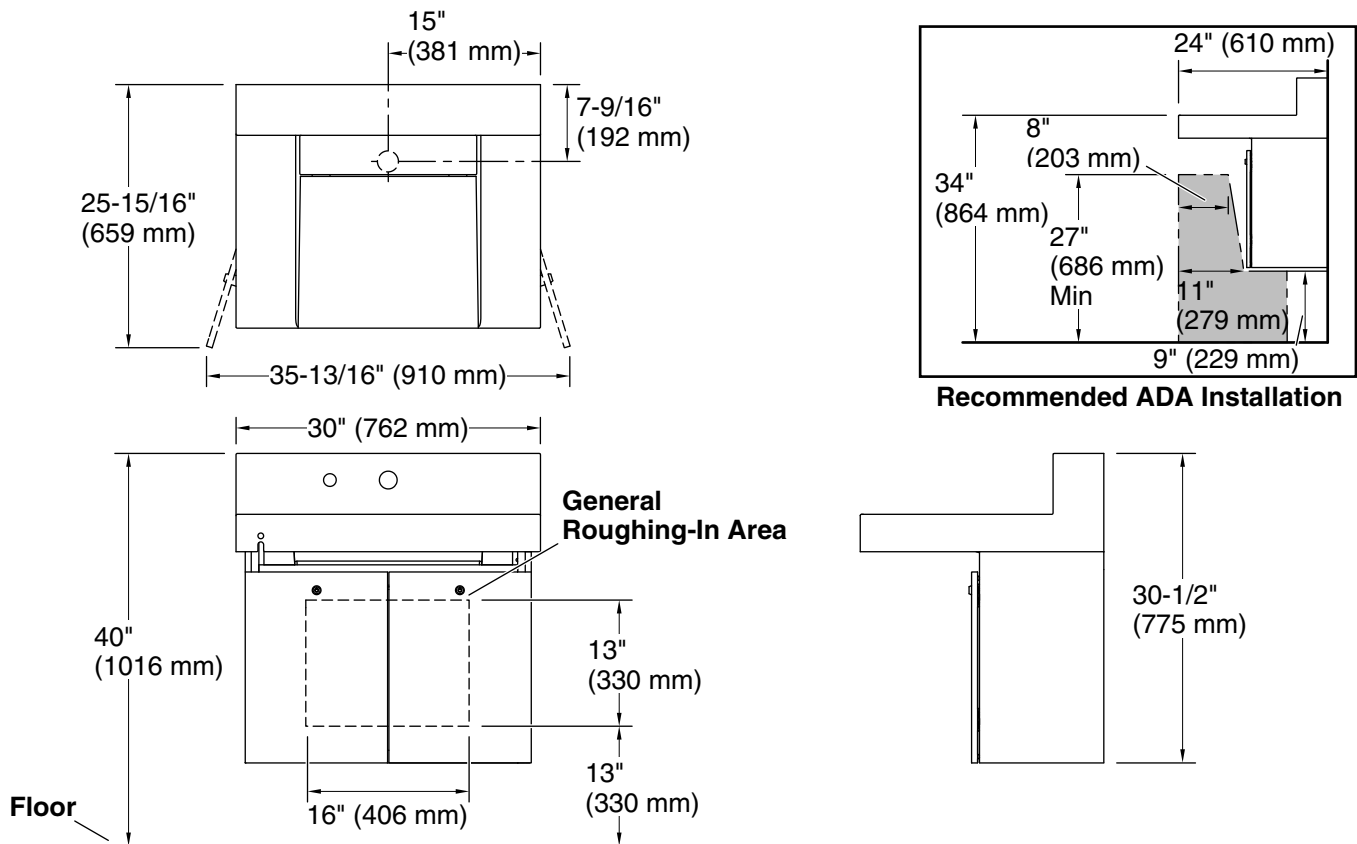

Technical Information

All product dimensions are nominal.

Min. base cabinet width: 24" (610 mm)

Drain hole: 1-3/4" (44 mm)

Notes

Install this product according to the installation instructions.

Select the type of fastener based upon the wall material. 500 lb (227 kg) minimum load bearing fasteners are recommended.

ADA, CSA B651 compliant when installed to the specific requirements of these regulations.