

Features

- For use with K-18829-NA 2"x4" in-wall tank and carrier system.
- Dual flush actuator offers a choice of 0.8 or 1.6 gallons per flush (gpf).
- Large flush actuator plate opening can be removed for easy access to inner tank.

Installation

- See installation guide for more detailed information.

Water Conservation & Rebates

- WaterSense® toilets meet strict EPA flushing guidelines, including using at least 20 percent less water than 1.6-gallon toilets.
- Eligible for consumer rebates in some municipalities.



Codes/Standards







None Applicable

KOHLER® One-Year Limited Warranty

See website for detailed warranty information.

Available Colors/Finishes

Color tiles intended for reference only.

Color	Code	Description
	CP	Polished Chrome
	0	White
	GB1	Glossy Black with Polished Chrome
	GW1	Glossy White with Polished Chrome
	GW2	Glossy White with Satin Chrome Accent
	GW3	Glossy White with Polished Gold Accent
	PC1	Polished Chrome with Brushed Chrome Accent

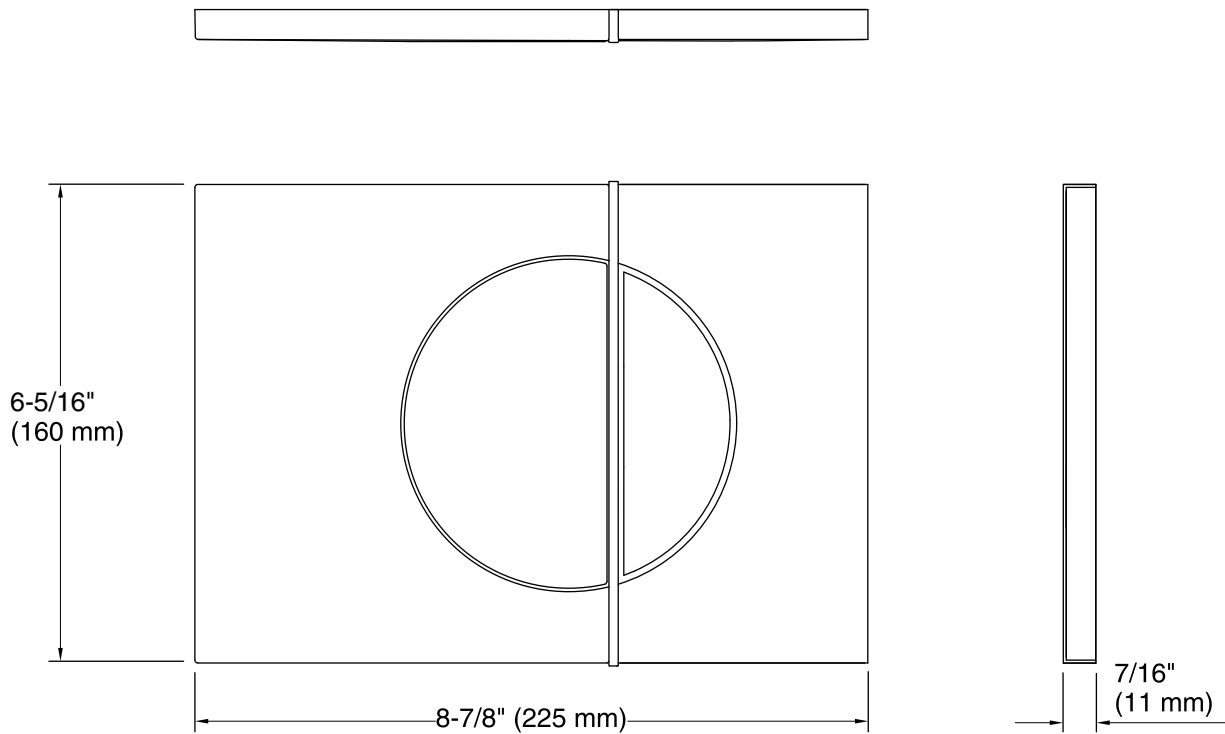

Technical Information

All product dimensions are nominal.

Material: Plastic

Notes

Install this product according to the installation guide.