

Features

- 9" (229 mm) spout reach.
- 2-7/8" (73 mm) high nondiverter spout.
- KOHLER ceramic disc valves exceed industry longevity standards for a lifetime of durable performance.
- Variety of handle style options (sold separately).
- Handle trim sold separately.
- Coordinates with other products in the Artifacts collection.

Material

- Brass.
- KOHLER finishes resist corrosion and tarnishing.

Installation

- Finished deck-mount installation only.

Required Products/Accessories

- K-T98071-3M Deck-mount Bath Faucet Trim
- or
- K-T98071-4 Deck-mount Bath Faucet Trim
- or
- K-T98071-9M Bath- or Deck-Mount Handles

Recommended Products/Accessories

- K-23723 Faucet cleaner
- K-72567 18" Towel Bar
- K-72568 24" Towel Bar
- K-72570 24" Double Towel Bar
- K-72571 Towel Ring
- K-72572 Robe Hook
- K-72573 Pivoting toilet paper holder
- K-72576 Toilet paper carriage

Included Components

- Additional Components:
1354692



Codes/Standards







ASME A112.18.1/CSA B125.1

KOHLER® Faucet Lifetime Limited Warranty

See website for detailed warranty information.

Available Colors/Finishes

Color tiles intended for reference only.

Color	Code	Description
	CP	Polished Chrome
	SN	Vibrant® Polished Nickel
	BN	Vibrant® Brushed Nickel
	BV	Vibrant® Brushed Bronze
	2BZ	Oil-Rubbed Bronze
	2MB	Vibrant® Brushed Moderne Brass

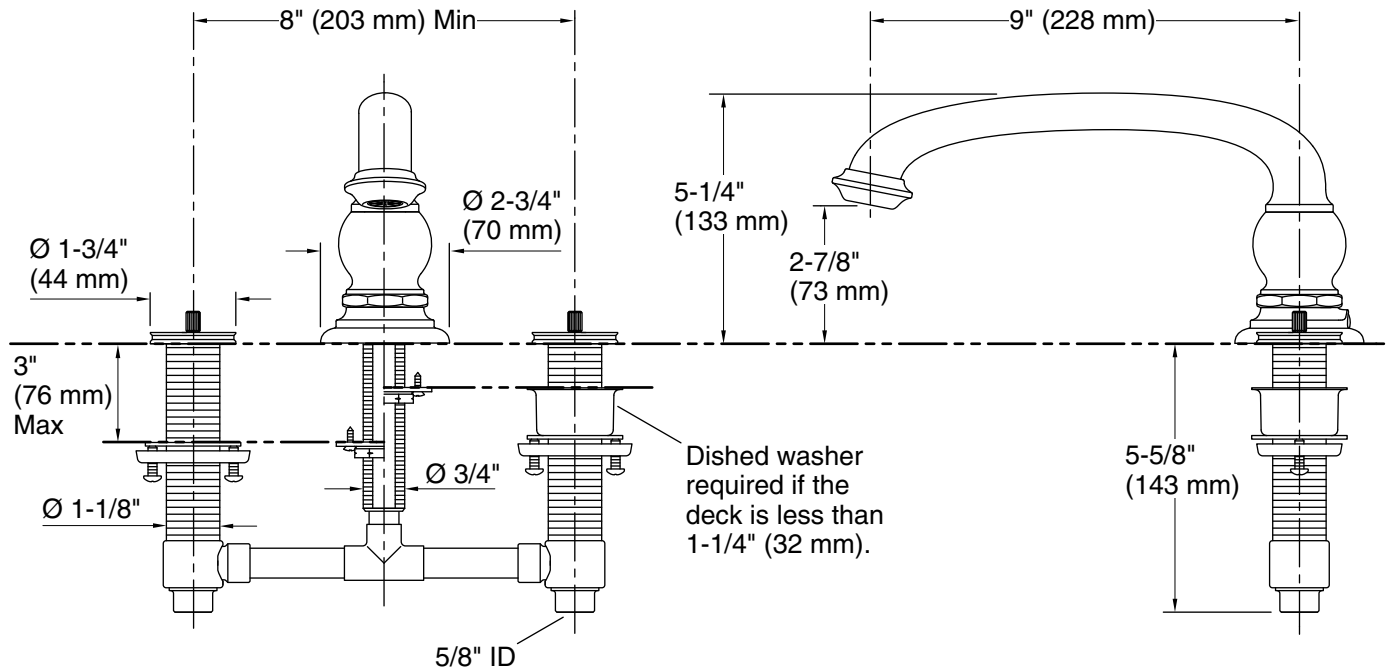

Technical Information

All product dimensions are nominal.

Spout:

Spout reach: 9" (229 mm)

Notes

IMPORTANT! Artifacts deck-mount handles are only compatible with the valve included with the Artifacts deck-mount faucets. Do not install to a K-300 bath valve.

IMPORTANT! For K-T98071-9M models, the handle swings up and toward the user. Ensure that the handle will not interfere with the bath fixture during operation.

Install this product according to the installation guide.

For a finished bath deck/rim less than 5/8" (16 mm) thick: Install wood reinforcing material to the underside of the deck/rim. The combined thickness of the reinforcing material and the deck/rim must not exceed 3" (76 mm).