

Features

- Oval-shaped basin creates a graceful and spacious bathing experience.
- Molded lumbar support offers extra comfort while bathing.
- Safeguard® slip-resistant surface on bath floor.

Material

- KOHLER® enameled cast iron.

Installation

- Drop-in

Additional Hydrotherapy Options

- Soaking Bath - 711-0
- BubbleMassage air bath - 712-G0
- Whirlpool - 712-H2

Recommended Products/Accessories

K-1172 Adjustable feet
K-1491 Bath/Whirlpool Pillow
K-1601 Bath/Whirlpool Footstop
K-7259 Clearflo Bath Drain



Codes/Standards

ASME A112.19.1/CSA B45.2
ASTM F462





KOHLER® Enameled Cast Iron Bath and Shower Base Lifetime Limited Warranty

See website for detailed warranty information.

Available Colors/Finishes

Color tiles intended for reference only.

Color	Code	Description
-------	------	-------------

	0	White
	96	Biscuit
	47	Almond
	NY	Dune
	G9	Sandbar

No change in measurements if connected with drain illustrated. (K-7103)

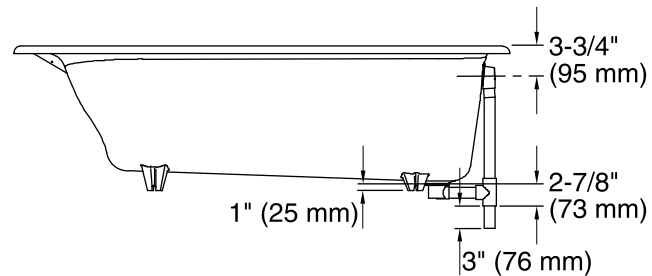
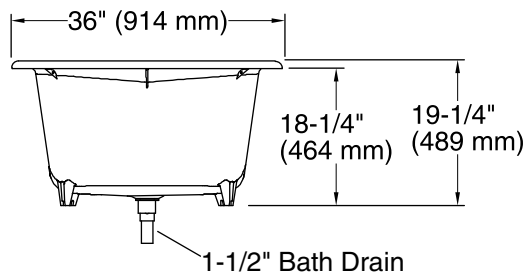
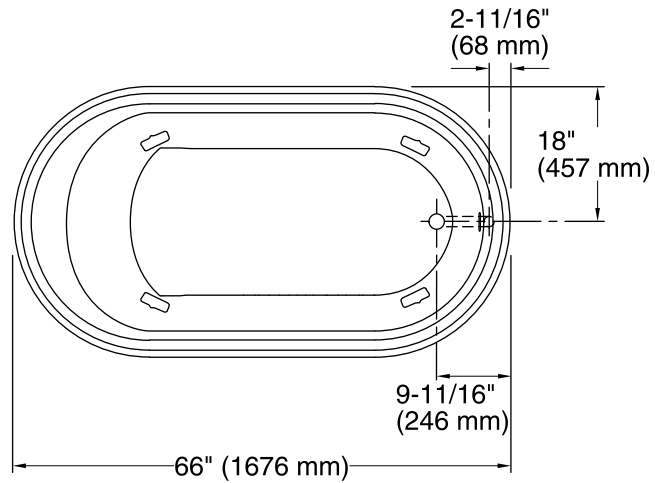

Technical Information

All product dimensions are nominal.

Installation:	Drop-in
Drain location:	End
Basin area, bottom:	47-1/2" x 25" (1207 mm x 635 mm)
Basin area, top:	55" x 29" (1397 mm x 737 mm)
Weight:	375 lbs (170.1 kg)
Minimum floor load:	57 lbs/ft ² (278.3 kg/m ²)
Water depth:	12-5/8" (321 mm)
Water capacity:	64 gal (242.3 L)
Template:	Drop-in, 88051-7, required, included

Notes

Measure your actual product for rough-in details.

Install this product according to the installation instructions.

The hot water supply should be 70% of the capacity of the bath or greater. Installations will vary.