

Technology

- Semi-frameless, 3/8-inch-thick Crystal Clear tempered glass.
- Inside and outside solid 12-inch handles.
- CleanCoat® nanotechnology helps prevent bacteria, mildew and water stains on your glass, making it easy to clean and looking new.
- Adjustable framing system simplifies installation for out-of-plumb shower openings.
- Can be installed to open to the left or right.

Installation

- Not for use in hospitality.
- For residential use only.

Included Components

Additional Components:
Hardware kit



Codes/Standards

CPSC 16CFR 1201
ANSI Z97.1

KOHLER® One-Year Limited Warranty

See website for detailed warranty information.

Available Colors/Finishes

Color tiles intended for reference only.

Color	Code	Description
-------	------	-------------

SH

NX

ABV

Available Glass Options

Code	Description
------	-------------

L Crystal Clear

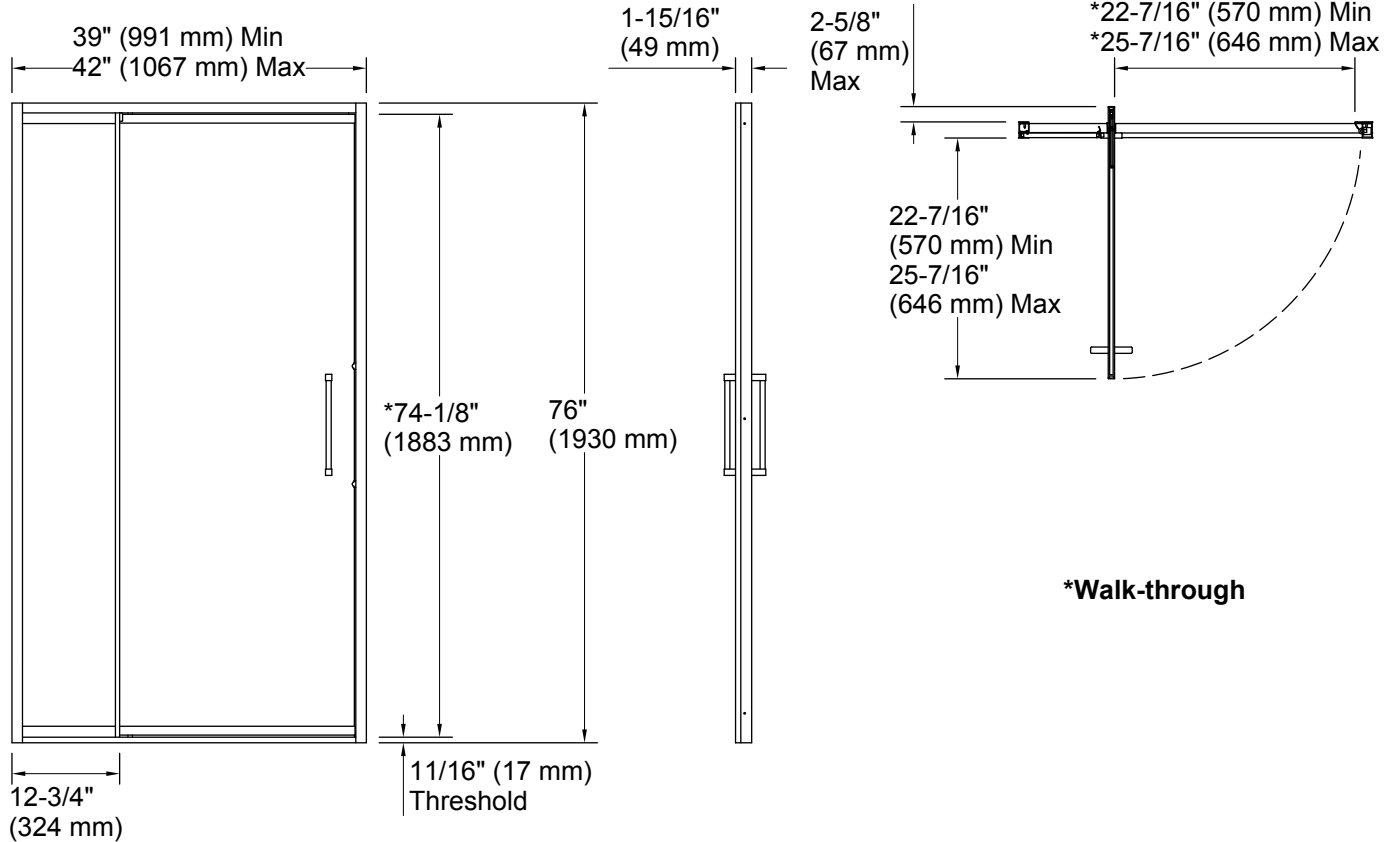

Technical Information

All product dimensions are nominal.

Installation type:	For shower base installation
Opening style:	Pivot
Opening Width - Min:	39" (991 mm)
Opening Width - Max:	42" (1067 mm)
Walk-through - Min:	22-7/16" (570 mm)
Walk-through - Max:	25-7/16" (646 mm)
Glass thickness:	3/8" (10 mm)
Glass coating:	CleanCoat®

Notes

Install this product according to the installation guide.

Recommended two person installation.

The vertical opening should be a minimum of 76-5/8" (1946 mm) to allow for installation clearance.