

Features

- Fits minimum 33-inch apron sink base cabinet.
- Single bowl.
- 8-inch depth.
- Integral apron.
- Three oversized faucet holes with one oversized accessory hole to the right.
- Oversized holes allow for easy installation of faucets and accessories.

Material

- KOHLER® enameled cast iron.

Installation

- Under-mount apron-front.

Recommended Products/Accessories

K-9000 P-Trap
K-6062 Sink Rack
K-6539 Drainboard with Sink Rack
K-6377 Sponge Caddy
K-6378 Kitchen Brush Caddy
K-6379 Kitchen Squeegee
K-6382 Disinfecting Wipes Dispenser
K-6383 Soap Dispenser
K-8618 Paper Towel Holder
K-8619 Flexible Kitchen Mat
K-8624 Dish Scraper
K-8801 Sink Strainer
K-8799 Sink Strainer

Optional Products/Accessories

K-5984 Cutting Board



Codes/Standards

















ASME A112.19.1/CSA B45.2

KOHLER® Enameled Cast Iron Kitchen Sink Lifetime Limited Warranty

See website for detailed warranty information.

Available Colors/Finishes

Color tiles intended for reference only.

Color	Code	Description
	0	White
	FF	Sea Salt™
	96	Biscuit
	47	Almond
	FD	Cane Sugar™
	NY	Dune
	95	Ice™ Grey
	G9	Sandbar
	33	Mexican Sand™
	K4	Cashmere
	FT	Basalt
	58	Thunder™ Grey
	20	Suede
	KA	Black 'n Tan
	FP	Caviar
	7	Black Black™

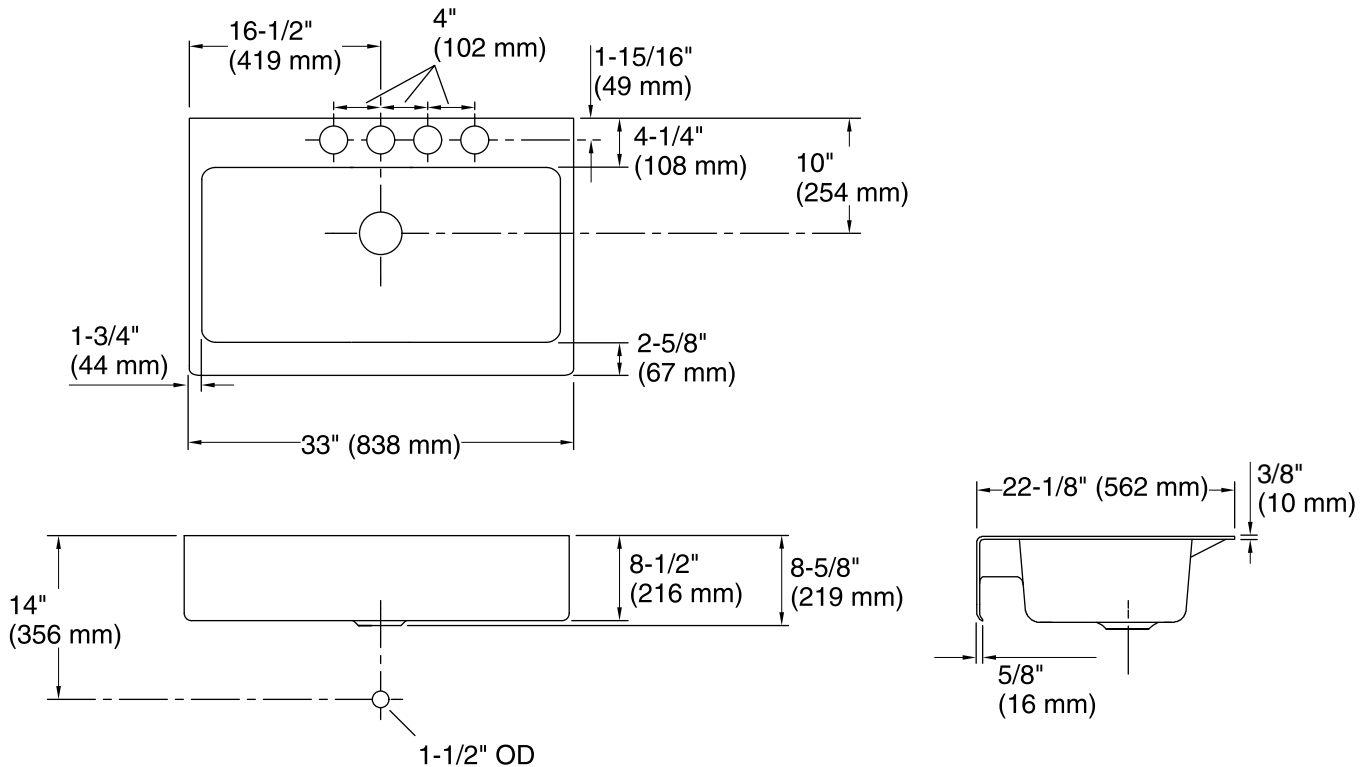

Technical Information

All product dimensions are nominal.

Bowl configuration:	Single
Installation:	Under-mount
Bowl area (Only):	Length: 29-1/2" (749 mm) Width: 15-1/4" (387 mm) Bowl depth: 8-5/8" (220 mm) Water depth: 8" (203 mm)
Number of deck holes:	4
Faucet hole spacing:	4" (102 mm)
Faucet hole(s):	2-3/8" (60 mm)

Notes

Install this product according to the installation instructions.

Due to the special nature of this installation, Kohler Co. recommends that an experienced cabinet maker use the actual sink to build the new cabinet or modify an existing cabinet.

For under-mount installations, allow a 3/4" (19 mm) reveal to support the K-5984 cutting board.