



Executive Chef™
 Top-mount Kitchen Sink
K-5932-4

Features

- 33-inch minimum base cabinet width.
- Large/medium bowls.
- 10-inch left depth and 8-inch right depth.
- Three faucet holes with one accessory hole to the right.
- Offset faucet ledge.

Material

- KOHLER® enameled cast iron.

Installation

- Top-mount

Recommended Products/Accessories

- K-9000 P-Trap
- K-6001 Left-Bowl Sink Rack
- K-6539 Drainboard with Sink Rack
- K-6377 Sponge Caddy
- K-6378 Kitchen Brush Caddy
- K-6379 Kitchen Squeegee
- K-8801 Sink Strainer
- K-8799 Sink Strainer

Optional Products/Accessories

- K-6515 Cutting Board
- K-6521 Sink Basket



Codes/Standards











ASME A112.19.1/CSA B45.2

KOHLER® Enameled Cast Iron Kitchen Sink Lifetime Limited Warranty

See website for detailed warranty information.

Available Colors/Finishes

Color tiles intended for reference only.

Color	Code	Description
	0	White
	96	Biscuit
	47	Almond
	FD	Cane Sugar™
	55	Innocent Blush™
	95	Ice™ Grey
	G9	Sandbar
	K4	Cashmere
	R1	Roussillon™ Red
	7	Black Black™
	97	Timberline™

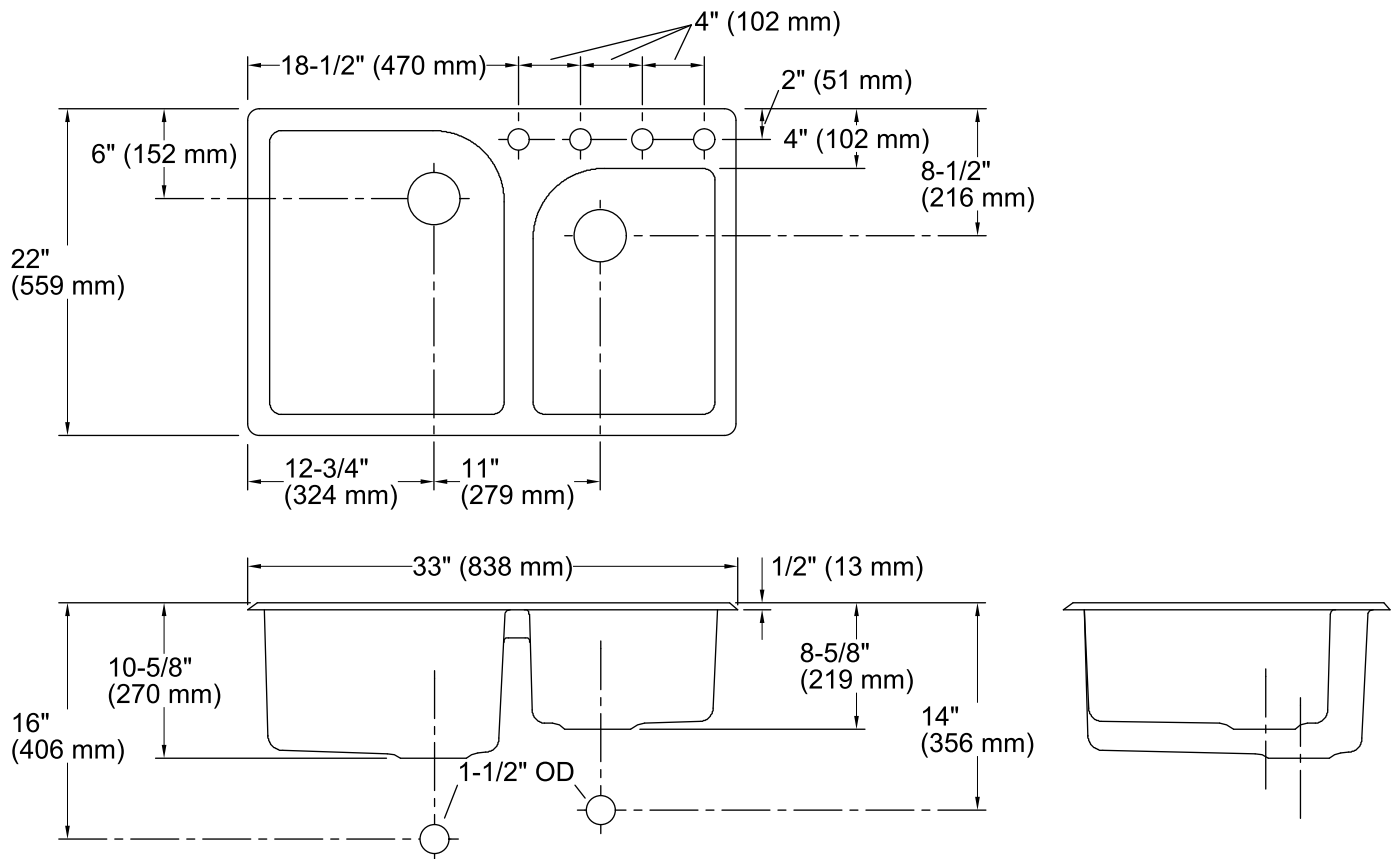

Technical Information

All product dimensions are nominal.

Bowl configuration:	Off-set Large/small
Installation:	Top-mount
Cutout:	Top-mount, 31-7/8" x 20-3/4" (810 mm x 527 mm) with 1-1/2" (38 mm) radius corners
Min. base cabinet width:	33" (838 mm)
Bowl area (Left):	Length: 16" (406 mm) Width: 19" (483 mm) Bowl depth: 9-3/4" (248 mm)
Bowl area (Right):	Length: 12" (305 mm) Width: 17" (432 mm) Bowl depth: 7-3/4" (197 mm)
Number of deck holes:	4
Faucet hole spacing:	4" (102 mm)
Faucet hole(s):	1-3/8" (35 mm)
Drain hole:	3-5/8" (92 mm)

Notes

Install this product according to the installation instructions.