



Bakersfield™

Top-mount Kitchen Sink
K-5832-4

Features

- 30-inch minimum base cabinet width.
- Single bowl.
- 8-inch depth.
- Three faucet holes with one accessory hole to the right.

Material

- KOHLER® enameled cast iron.

Installation

- Top-mount

Recommended Products/Accessories

- K-9000 P-Trap
- K-6517 Sink Rack
- K-6539 Drainboard with Sink Rack
- K-6377 Sponge Caddy
- K-6378 Kitchen Brush Caddy
- K-6379 Kitchen Squeegee
- K-6382 Disinfecting Wipes Dispenser
- K-6383 Soap Dispenser
- K-8618 Paper Towel Holder
- K-8619 Flexible Kitchen Mat
- K-8624 Dish Scraper
- K-8801 Sink Strainer
- K-8799 Sink Strainer

Optional Products/Accessories

- K-5836 Cutting Board



Codes/Standards







ASME A112.19.1/CSA B45.2

KOHLER® Enameled Cast Iron Kitchen Sink Lifetime Limited Warranty

See website for detailed warranty information.

Available Colors/Finishes

Color tiles intended for reference only.

Color	Code	Description
	0	White
	96	Biscuit
	47	Almond
	95	Ice™ Grey
	G9	Sandbar
	7	Black Black™

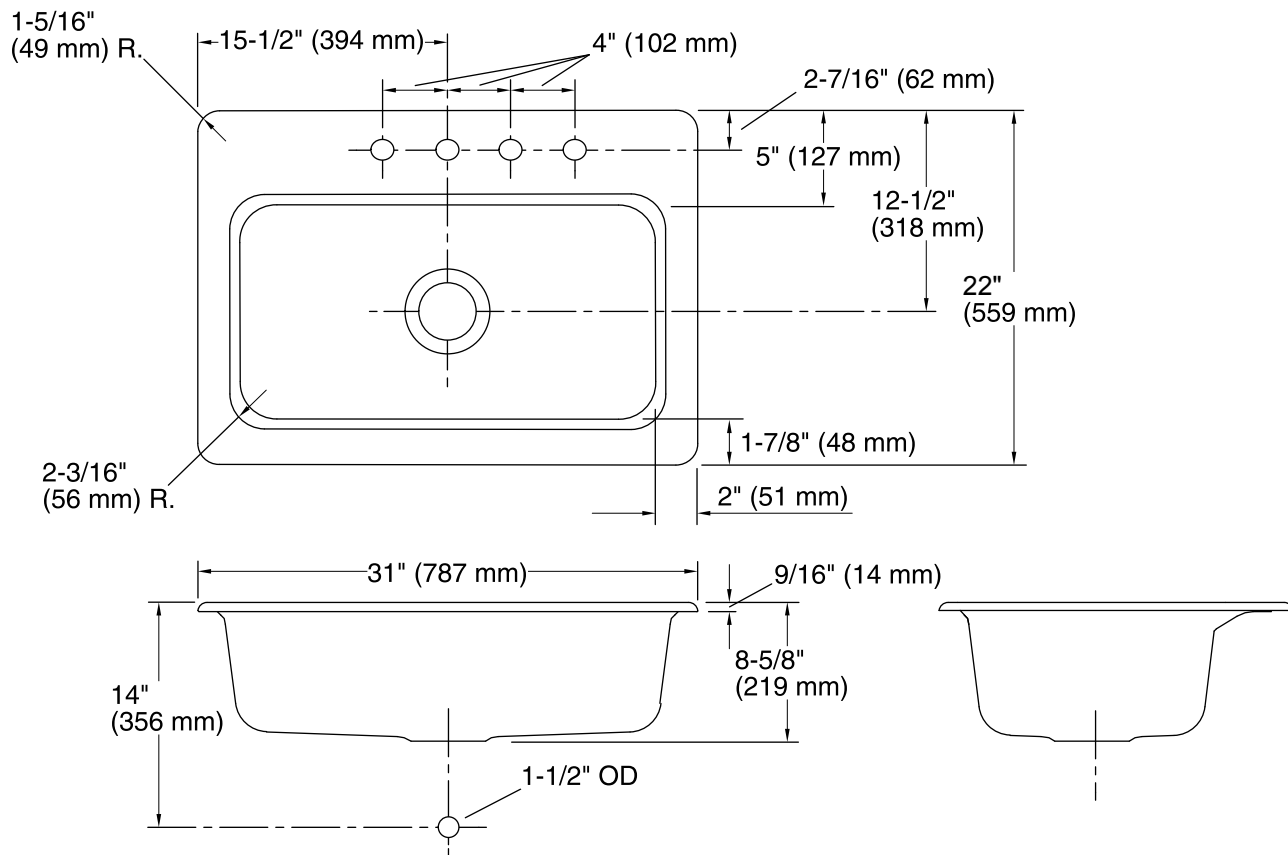

Technical Information

All product dimensions are nominal.

Bowl configuration:	Single
Installation:	Top-mount
Cutout:	Top-mount, 29-3/4" x 20-3/4" (756 mm x 527 mm) with 1" (25 mm) radius corners
Min. base cabinet width:	30" (762 mm)
Bowl area:	Length: 27" (686 mm) Width: 15" (381 mm) Bowl depth: 8" (203 mm)
Number of deck holes:	4
Faucet hole spacing:	4" (102 mm)
Faucet hole(s):	1-3/8" (35 mm)
Drain hole:	3-5/8" (92 mm)

Notes

Install this product according to the installation instructions.

Cut-out is 29-3/4" (756 mm) by 20-3/4" (527 mm) with 1" (25 mm) radius corners.