

Features

- VibrAcoustic calms and soothes with sound vibration technology.
- Six concealed speakers send sound waves through the water to gently massage the body.
- Four original instrumental compositions offer different levels of relaxation.
- Syncs with devices enabled with BLUETOOTH® wireless technology including smartphones, MP3 players, tablets, and laptops located up to 33 feet away.*
- Customize your experience with the high-resolution color touch screen.
- Fully adjustable volume above and below the water.
- Functions as a hydrotherapy bath when full of water and a stereo system when empty.
- Molded lumbar support offers extra comfort while bathing.
- Oval-shaped basin offers a graceful and spacious bathing experience.
- Slotted overflow allows for deep soaking.
- Includes 25 feet of wiring and amplifier.
- Requires K-7271 or K-7272 Clearflo slotted overflow bath drain (sold separately).
- Center drain.

Material

- Acrylic

Hydrotherapy

- VibrAcoustic

Installation

- Drop-in or under-mount.
- Requires 110V electrical service.

Additional Hydrotherapy Options

- Soaking Bath - 5713-0
- Soaking Bath + Bask heated surface - 5713-W1
- BubbleMassage air bath - 5714-G
- BubbleMassage air bath + chromatherapy - 5714-GCR
- VibrAcoustic + BubbleMassage air bath - 5714-GVB
- VibrAcoustic + BubbleMassage air bath + Bask heated surface + chromatherapy - 5714-GVBCW
- BubbleMassage air bath + Bask heated surface - 5714-GW
- Whirlpool + heater - 5714-H2
- VibrAcoustic - 5714-VB
- VibrAcoustic + chromatherapy - 5714-VBC
- VibrAcoustic + chromatherapy + Bask heated surface - 5714-VBCW
- VibrAcoustic + Bask heated surface - 5714-VBW
- Whirlpool + BubbleMassage air bath - 5714-XH2G



Codes/Standards

CSA B45.5/IAPMO Z124
ASTM E162
ASTM E662
UL 1795
CSA C22.2 No. 218.2











KOHLER® Plastic Baths and Receptors Lifetime Limited Warranty

See website for detailed warranty information.

The BLUETOOTH® word mark and logos are registered trademarks owned by Bluetooth SIG, Inc. and any use of such marks by Kohler Co. is under license. Other trademarks and trade names are those of their respective owners.

Available Colors/Finishes

Color tiles intended for reference only.

Color	Code	Description
	0	White
	96	Biscuit
	47	Almond
	NY	Dune
	95	Ice™ Grey
	G9	Sandbar
	33	Mexican Sand™
	K4	Cashmere
	58	Thunder™ Grey
	7	Black Black™

No change in measurements if connected with drain illustrated. (K-7272)

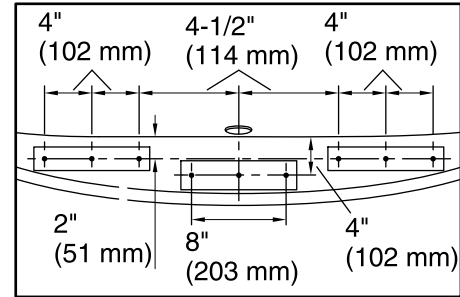
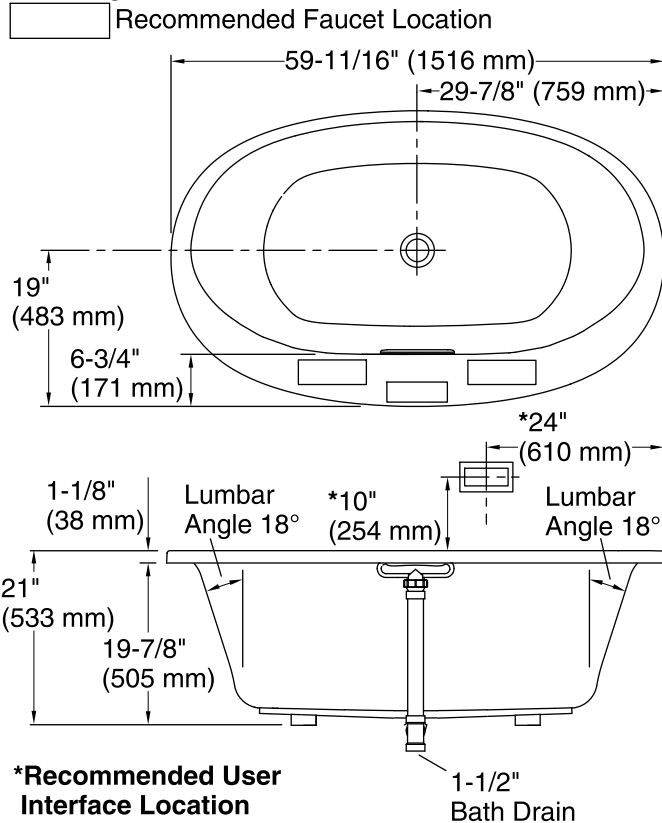

Recommended Faucet Hole Location

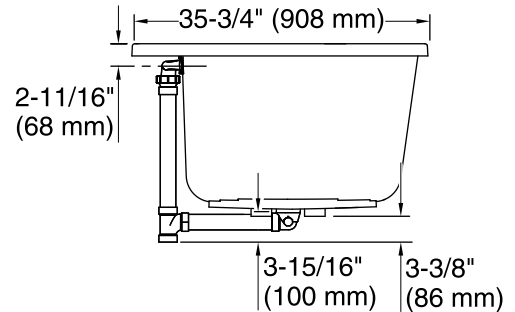
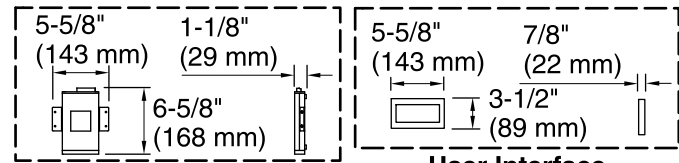

Required Electrical Service

One circuit required, protected with Class A Ground-Fault Circuit-Interrupter (GFCI). Outside North America, this device may be known as a Residual Current Device (RCD).

Amplifier: 120 V, 15 A, 50/60 Hz

Technical Information

All product dimensions are nominal.

Installation:	Drop-in, Under-mount
Drain location:	Center
Basin area, bottom:	43" x 25-5/8" (1093 mm x 651 mm)
Basin area, top:	55-9/16" x 28-3/8" (1411 mm x 720 mm)
Weight:	90 lbs (40.8 kg)
Minimum floor load:	49.2 lbs/ft ² (240.2 kg/m ²)
Water depth:	16-5/16" (415 mm)
Water capacity:	72.017 gal (272.6 L)
Template:	Drop-in, 1268438-7, required, included
Electrical component rating:	Amplifier: 120 V, 1.1 A, 50/60 Hz
Amplifier channels:	2 at 15 W per channel 2 at 30 W per channel
Bluetooth® range:	33 ft (0.8 m)

Notes

Measure your actual product for rough-in details. Install this product according to the installation instructions.

The hot water supply should be 70% of the capacity of the bath or greater. Installations will vary.

Control amplifier fits 16" (406 mm) center studs. Kit is required for under-mount installations (sold separately).

Provide a separate grounded outlet if connecting to a powered wireless device or adapter.