



Iron Plains®

20-3/4" oval vessel bathroom sink
K-5403-PFG

Features

- Oval basin
- No faucet holes; requires wall- or counter-mount faucet
- With overflow
- Enameled Fresh Green interior and painted Fresh Green underside

Material

- KOHLER® enameled cast iron
- Acid-resistant enamel finish

Installation

- Vessel

Recommended Products/Accessories

- K-23726 Drain treatment
- K-23725 Cast iron cleaner



ADA

CSA B651

Codes/Standards

ASME A112.19.1/CSA B45.2
ADA
ICC/ANSI A117.1
CSA B651
IAPMO Certification

KOHLER® Enameled Cast Iron Kitchen and Bathroom Sink Lifetime Limited Warranty

See website for detailed warranty information.

Available Colors/Finishes

Color tiles intended for reference only.

Color	Code	Description
-------	------	-------------

	34	Fresh Green
---	----	-------------

1-800-4KOHLER (1-800-456-4537)

Kohler Co. reserves the right to make revisions without notice to product specifications.

For the most current Specification Sheet, go to www.kohler.com USA or www.kohler.ca Canada

6-8-2024 21:11 - US

THE BOLD LOOK
OF **KOHLER**®

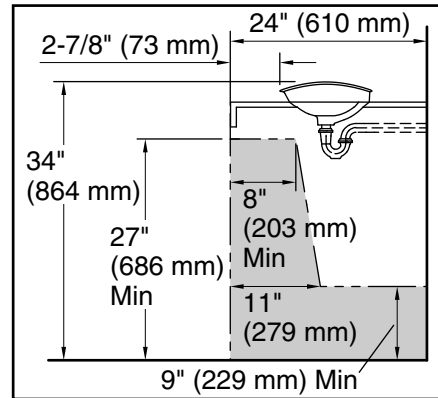
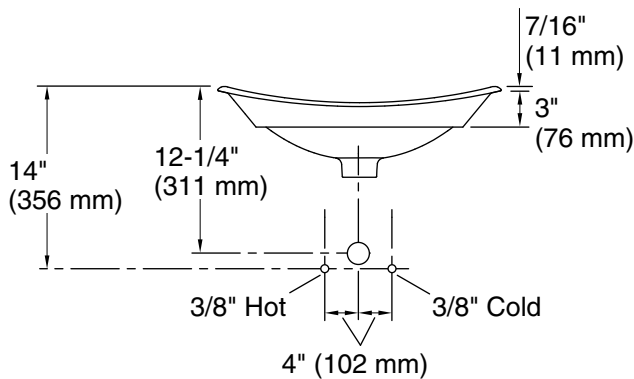
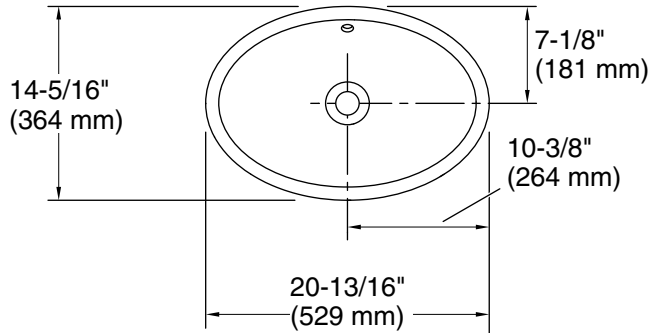

Recommended ADA Installation

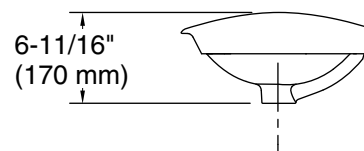

Technical Information

All product dimensions are nominal.

- Bowl configuration: Single
- Bowl area: Length: 19-3/4" (501 mm)
Width: 13-1/4" (337 mm)
Bowl depth: 4-15/16" (126 mm)
Water depth: 2-1/4" (58 mm)
- With overflow: Yes
- Drain hole: 1-3/4" (44 mm)
- Template: 1222633-7, required, included

Notes

Install this product according to the installation instructions.

If included, add the following note # NOTICE: Countertop manufacturer or cutter must use the cut-out template provided with the product, or a current one provided by Kohler Co. (call 1-800-4KOHLER). Kohler Co. is not responsible for cutout errors when the incorrect cut-out template is used.

ADA, CSA B651 compliant when installed to the specific requirements of these regulations.