

Features

- Brass construction.
- Brass valve bodies.
- Quarter-turn washerless ceramic disc valves.
- Pop-up drain with lift rod and tailpiece.
- Stately Faceted lever handles.
- 5" (127 mm) spout reach.
- Stationary spout.
- For 8" (203 mm) or 16" (406 mm) centers.
- 1.2 gal/min (4.5 l/min) maximum flow rate [max at 60 psi (4.14 bar)].

Material

- KOHLER finishes resist corrosion and tarnishing.

Optional Products/Accessories

1160593 .35 gpm Aerator, Small



ADA OBC

Codes/Standards

ASME A112.18.1/CSA B125.1

NSF/ANSI 61

NSF/ANSI 372

All applicable US Federal and State material regulations

DOE - Energy Policy Act 1992

EPA WaterSense®

California Energy Commission (CEC)

ADA

ICC/ANSI A117.1







OBC

KOHLER® Faucet Lifetime Limited Warranty

See website for detailed warranty information.

Available Colors/Finishes

Color tiles intended for reference only.

Color	Code	Description
	CP	Polished Chrome
	AF	Vibrant® French Gold
	PB	Vibrant® Polished Brass
	G	Brushed Chrome
	BN	Vibrant® Brushed Nickel
	BV	Vibrant® Brushed Bronze

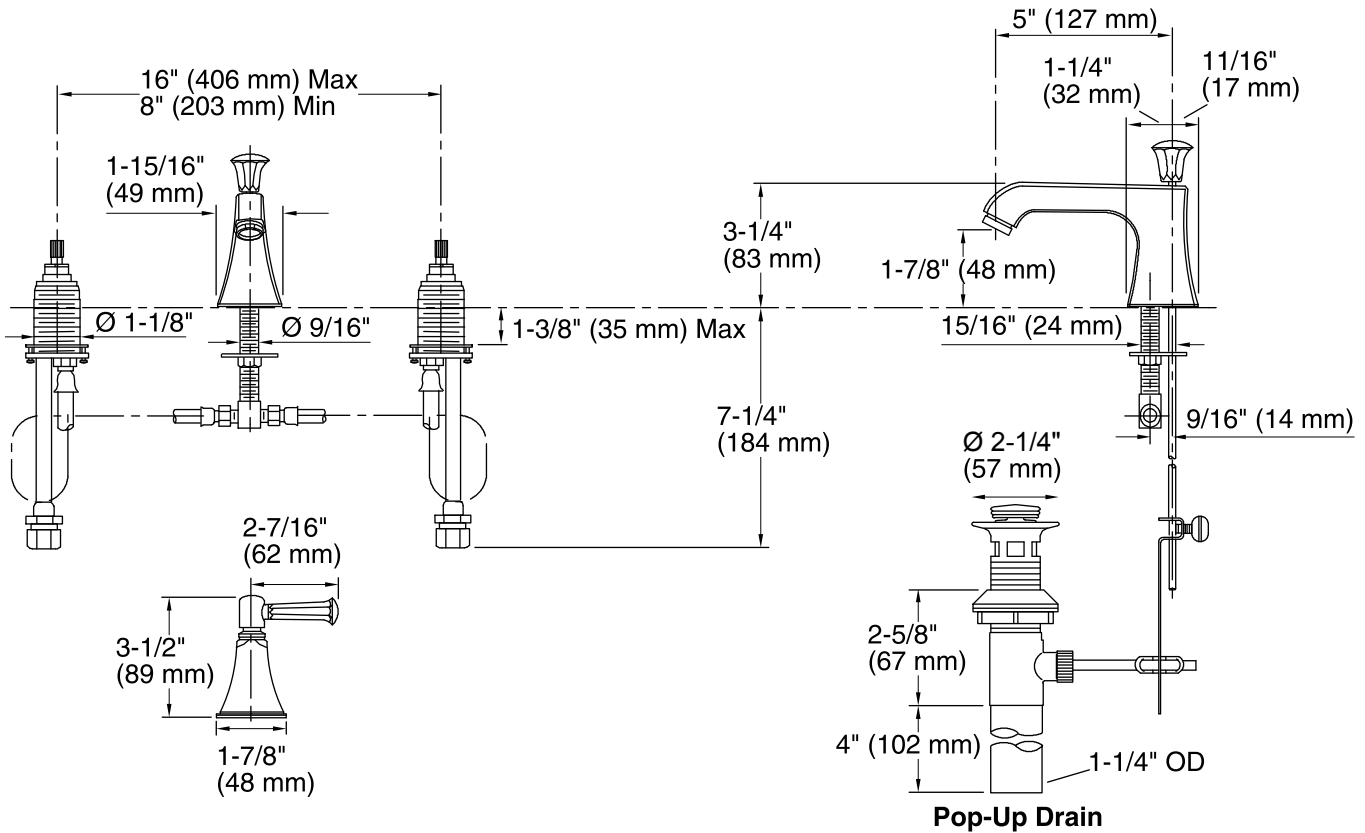

Technical Information

All product dimensions are nominal.

Faucet:

Flow rate: 1.2 gal/min (4.5 l/min)

Pressure: 60 psi (4.1 bar)

Drain included: Yes

Drain tailpiece included: Yes

Spout:

Spout reach: 5" (127 mm)

Notes

Install this product according to the installation guide.

ADA, OBC compliant when installed to the specific requirements of these regulations.