

Features

- Two-piece toilet.
- Round-front bowl offers an ideal solution for smaller baths and powder rooms.
- Comfort Height® feature offers chair-height seating that makes sitting down and standing up easier for most adults.
- 1.28 gallons per flush (gpf).
- 2-1/8-inch glazed trapway.
- Standard left-hand Polished Chrome trip lever included.
- Combination consists of the K-4387 bowl and the K-4433 tank.
- Coordinates with other products in the Memoirs collection with Stately design.

Technology

- Single-flush gravity uses the force of gravity and a precision-engineered tank, bowl, and trapway to create a strong siphon during flushing.
- AquaPiston canister allows water to flow into the bowl from all sides (360 degrees), increasing the power and effectiveness of the flush.
- Flush valve's 3:2 ratio harnesses the natural force of gravity and optimizes flush performance.
- Durable canister design has 90% less exposed seal material than a 3-inch flapper, for leak-free performance.
- Light-touch canister flush requires a lower actuation force than a flapper.
- AquaPiston canister flush valve optimizes flush performance and resists warping and deterioration.

Installation

- Standard 12-inch rough-in.
- Three-bolt installation.
- Seat and supply line not included.

Water Conservation & Rebates

- WaterSense® toilets meet strict EPA flushing guidelines, including using at least 20 percent less water than 1.6-gallon toilets.
- Eligible for consumer rebates in some municipalities.

Recommended Products/Accessories

K-4639 Cachet® Quiet-Close™ Round-Front Toilet Seat
K-5589 Purefresh® Round-Front Toilet Seat
K-76923 Puretide™ Quiet-Close™ round-front manual cleansing toilet seat
K-5420 Low-Profile Bolt Caps
K-9167-L Trip Lever
K-484 Trip Lever
1023457 Wax Ring/Hardware Kit
1265114 Connector Hose



ADA

Codes/Standards







ASME A112.19.2/CSA B45.1
DOE - Energy Policy Act 1992
EPA WaterSense®
ADA
ICC/ANSI A117.1

KOHLER® One-Year Limited Warranty

See website for detailed warranty information.

Available Colors/Finishes

Color tiles intended for reference only.

Color	Code	Description
	0	White
	96	Biscuit
	47	Almond
	NY	Dune
	95	Ice™ Grey
	G9	Sandbar
	7	Black Black™

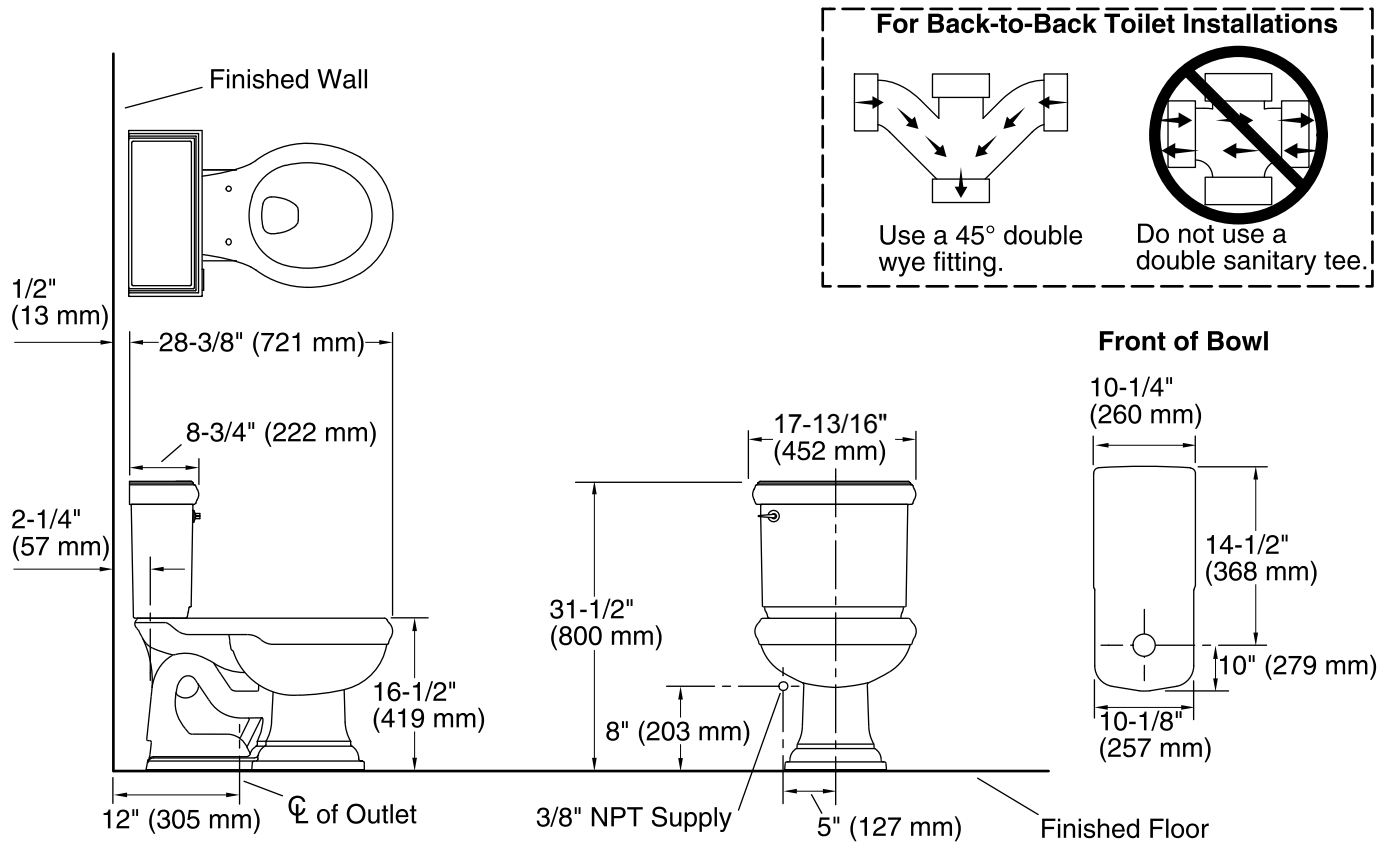

Technical Information

All product dimensions are nominal.

Toilet type:	Two-piece, Floor-mount
Waste Outlet:	Floor
Bowl shape:	Round-front
Flush type:	AquaPiston®
Trap passageway:	2-1/8" (54 mm)
Water Consumption	
Full:	1.28 gpf (4.8 lpf)
Water surface size:	11-1/2" x 8-3/4" (292 mm x 222 mm)
Rim to water surface:	6-1/8" (156 mm)
Rough-in:	12" (305 mm)
Seat-mounting holes:	5-1/2" (140 mm)

Notes

Install this product according to the installation instructions.

For back-to-back toilet installations: Use only a 45° double wye fitting.

ADA compliant when installed to the specific requirements of these regulations.

Plumbing codes may require elongated toilets and elongated, open-front seats in public bathrooms.

Accessibility standards may require controls to be located on the open side of the toilet.