



WasteLAB™ | K-38324

26" planter

Features

- 25" (635 mm)L x 24-3/4" (630 mm)W x 27-3/8" (695 mm)H
- Manufactured from at least 70% material derived from the Kohler manufacturing waste stream
- Suitable for indoor and outdoor use
- Drainage holes and planter stand included



Sustainability



Available Colors/Finishes

Color tiles intended for reference only.

- AHN Ashen



1-800-4KOHLER (1-800-456-4537)
Kohler Co. reserves the right to make revisions without notice to product specifications.
For the most current specification sheet, go to www.kohler.com USA or www.kohler.ca Canada.
3-27-2026 17:49 - US-CA

THE BOLD LOOK
OF **KOHLER**

Codes/Standards

None Applicable

Material

- Ashen color: Vitreous cull, foundry sand, and foundry dust
 - KOHLER® enameled cast iron
-

Warranty

See website for detailed warranty information.

KOHLER® One-Year Limited Warranty



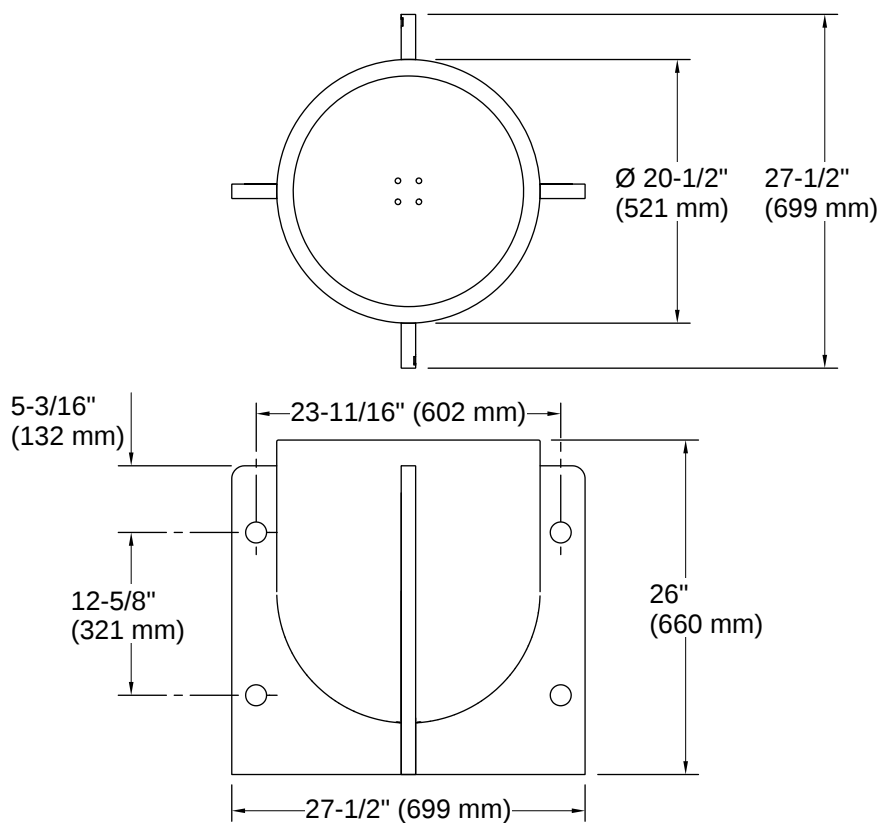

Installation Notes

Install this product according to the installation instructions.

