

### Features

- 21" (533 mm) minimum base cabinet width
- Single bowl
- 9" (229 mm) depth provides generous workspace
- Rear drain placement increases cabinet storage space underneath sink
- Rounded 3/8" (10 mm) corners are easy to clean
- Matte finish offers rich, dimensional color

### Material

- KOHLER Neoroc® composite is durable and built to withstand day-to-day cleaning tasks
- Solid color throughout the sink
- Heat-resistant up to 750°F
- Scratch-, stain-, chip-, and thermal-shock-resistant

### Installation

- Undermount
- Installation hardware and templates included

### Recommended Products/Accessories

- K-35478 Three-piece workstation sink accessory set
- K-35480 Hardwood cutting board
- K-35489 HDPE cutting board
- K-35484 Three-piece workstation sink prep bowl set
- K-35491 Marble serving tray
- K-35487 Three-piece ice bucket set
- K-35488 Ice bucket holder
- K-35492 Bar sink cover

### Optional Products/Accessories

- K-23726 Drain treatment
- K-23730 Neoroc® cleaner
- K-8799 Sink drain and strainer basket
- K-8801 Sink drain and strainer with tailpiece
- K-35482 Drain cover

### Included Components

- K-33717 Sink rack



### Codes/Standards







CSA B45.5/IAPMO Z124  
IAPMO Certification

### KOHLER® Neoroc® Sinks Lifetime Limited Warranty

See website for detailed warranty information.

### Available Colors/Finishes

*Color tiles intended for reference only.*

Color	Code	Description
	CM7	Matte Graphite
	CM6	Matte White
	CM4	Matte Grey
	CM2	Matte Brown
	CM1	Matte Black
	CM3	Matte Taupe

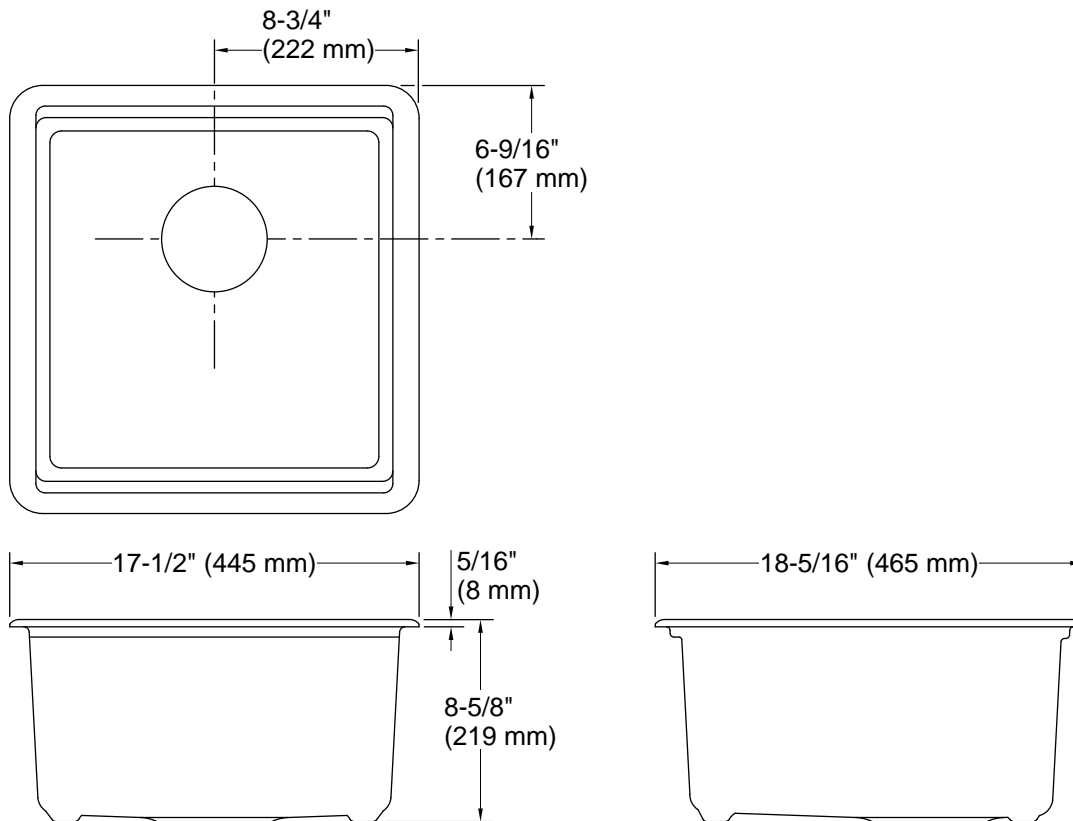

## Technical Information

All product dimensions are nominal.

Basin configuration: Single Bowl  
Min. base cabinet width: 21" (533 mm)

Bowl area (Basin #1):  
Length: 15-1/4" (387 mm)  
Width: 15-9/16" (395 mm)  
Bowl depth: 8" (203 mm)  
Water depth: 8" (203 mm)

With overflow: No

Drain hole: 3-7/8" (98 mm)

Template: Undermount, 1559205-7, required, included

## Notes

Install this product according to the installation instructions.