

Features

- Fits minimum 36" (914 mm) apron sink base cabinet
- Self-Trimming® apron overlaps cabinet face for easy installation and beautiful results
- Single large bowl
- 9-1/8" (232 mm) depth provides generous workspace
- Right rear drain placement increases workspace in the sink and storage space underneath
- Rounded 3/8" (10 mm) corners are easy to clean
- SilentShield® sound-absorption technology offers quieter performance
- All included accessories nest neatly together for easy storage when not in use
- Included accessories: cutting board, drain board, colander / drying rack, soaking bin with drain, stainless steel bottom sink rack, drain cover
- Sink drain and strainer sold separately

Material

- Premium 16-gauge stainless steel

Installation

- Undermount
- Installation hardware and templates included

Recommended Products/Accessories

- K-35489 HDPE cutting board
- K-35491 Marble serving tray
- K-35485 Workstation sink cover

Optional Products/Accessories

- K-8801 Sink drain and strainer with tailpiece
- K-23729 Stainless steel cleaner

Included Components

- K-35478 Three-piece workstation sink accessory set
- K-35482 Drain cover



Codes/Standards

ASME A112.19.3/CSA B45.4

KOHLER® Stainless Steel Sinks Lifetime Limited Warranty

See website for detailed warranty information.

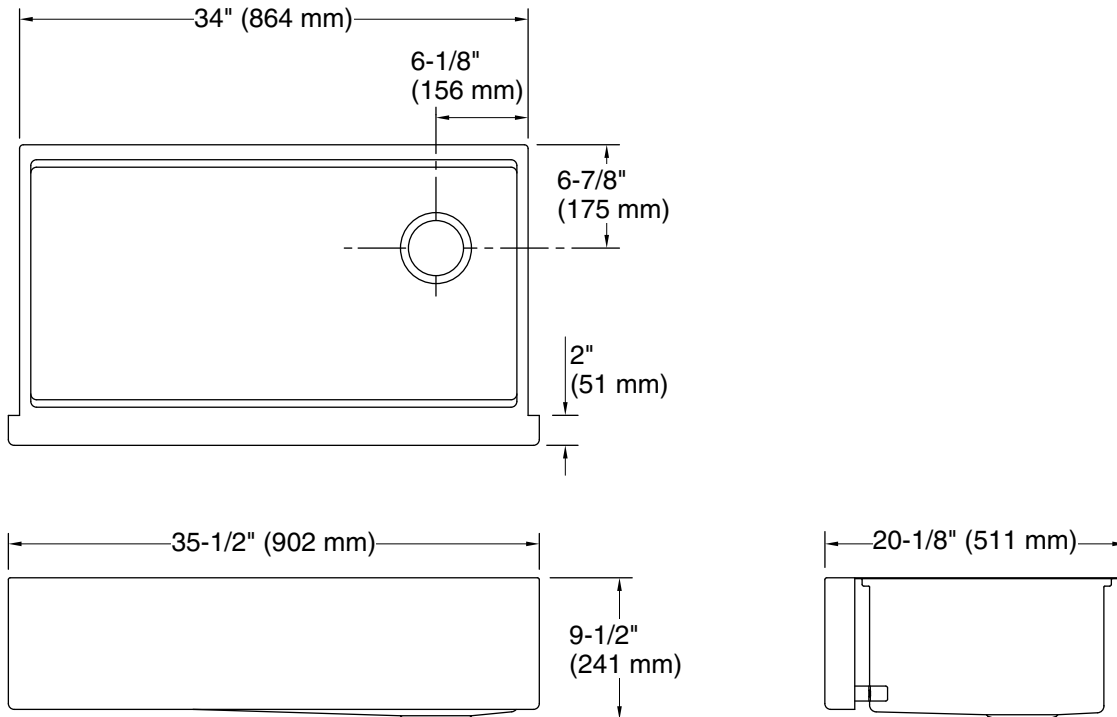

Technical Information

All product dimensions are nominal.

Bowl configuration: Single

Min. base cabinet width: 36" (914 mm)

Bowl area (Only): Length: 32-1/2" (826 mm)
Width: 15-9/16" (395 mm)
Bowl depth: 9-1/8" (232 mm)
Water depth: 9-1/8" (232 mm)

Drain hole: 3-3/4" (94 mm)

Template: Undermount, 1564885-7, required, included

Notes

Install this product according to the installation instructions.

"IMPORTANT! The distance from the top edge of the cabinet to the top of the cabinet door must be at least 8-15/16" (227 mm) to install this sink."

"NOTICE: Countertop manufacturer or cutter must use the cut-out template provided with the product, or a current one provided by Kohler Co. (call 1-800-4KOHLER). Kohler Co. is not responsible for cutout errors when the incorrect cut-out template is used."