

Features

- High-arch swing spout with 155° rotation offers superior clearance and unrivaled reach for filling pitchers and standard cleanup
- Innovative two-function aerator allows users to switch from aerated stream to SoftRinse™ spray with a simple 30° twist of the end of the spout
- SoftRinse™ is a light spray ideal for washing hands or rinsing glassware
- KOHLER® ceramic disc valves exceed industry longevity standards for a lifetime of durable performance
- Single lever handle makes adjusting water temperature easy with one hand
- Temperature memory allows faucet to be turned on and off at the temperature set during prior usage
- 1.5 gpm (5.7 lpm) maximum flow rate at 60 psi (4.14 bar)

Material

- Premium metal construction for durability and reliability
- KOHLER® finishes resist corrosion and tarnishing

Installation

- Two-hole installation
- Flexible supply lines simplify installation

Recommended Products/Accessories

K-23723 Faucet cleaner



ADA

CSA B651

Codes/Standards









ASME A112.18.1/CSA B125.1
NSF/ANSI/CAN 61
NSF/ANSI/CAN 372
All applicable US Federal and State material regulations
DOE - Energy Policy Act 1992
California Energy Commission (CEC)
ADA
ICC/ANSI A117.1
CSA B651

KOHLER® Faucet Lifetime Limited Warranty

See website for detailed warranty information.

Available Colors/Finishes

Color tiles intended for reference only.

Color	Code	Description
	CP	Polished Chrome
	SN	Vibrant® Polished Nickel
	AF	Vibrant® French Gold
	VS	Vibrant® Stainless
	BV	Vibrant® Brushed Bronze
	BL	Matte Black
	2MB	Vibrant® Brushed Moderne Brass
	BMB	Matte Black with Moderne Brass
	TT	Vibrant Titanium

1-800-4KOHLER (1-800-456-4537)

Kohler Co. reserves the right to make revisions without notice to product specifications.

For the most current Specification Sheet, go to www.kohler.com USA or www.kohler.ca Canada

6-11-2024 20:59 - US

THE BOLD LOOK
OF **KOHLER®**

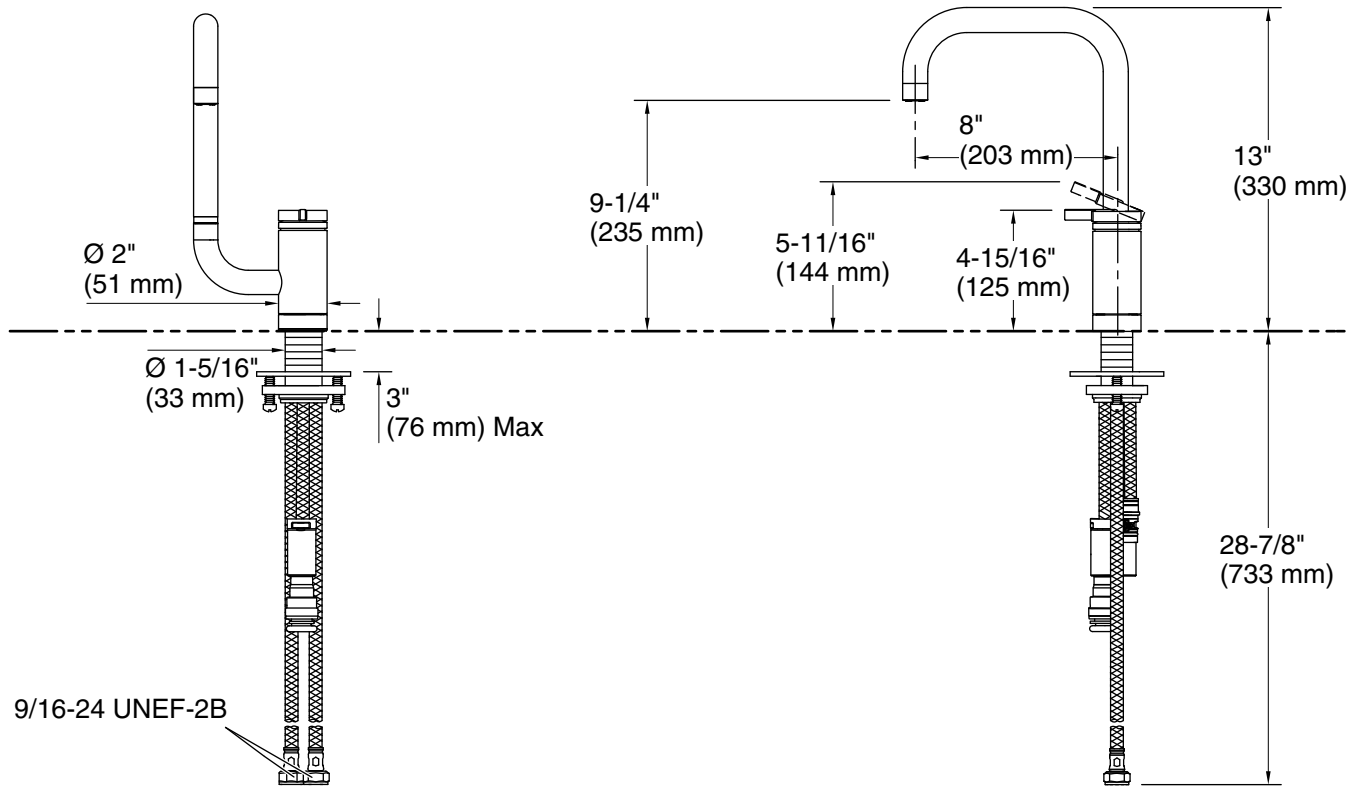

Technical Information

All product dimensions are nominal.

Faucet:

Flow rate: 1.5 gal/min (5.7 l/min)

Sidespray:

Flow rate: 2.2 gal/min (8.3 l/min)

Pressure: 60 psi (4.1 bar)

Drain included: No

Spout:

Spout reach: 8" (203 mm)

Notes

Install this product according to the installation guide.

ADA, CSA B651 compliant when installed to the specific requirements of these regulations.