

Features

- Slotted overflow allows for deep soaking
- 13-1/4" (337 mm) deep-soaking depth provides a relaxing bathing experience
- Integral lumbar support and neck rest offer extra comfort while bathing
- Low step-over height allows easy entry and exit
- Integral overflow and preinstalled toe-tap drain reduce installation time
- Toe-tap drain color-matched to the bath
- Integral apron creates a clean, finished look
- Textured bottom surface

Material

- Acrylic

Installation

- Alcove
- Right drain



ADA

Codes/Standards

CSA B45.5/IAPMO Z124
ASTM E162
ASTM E662
ADA
ICC/ANSI A117.1



KOHLER® Plastic Baths and Shower Bases Lifetime Limited Warranty

See website for detailed warranty information.

Available Colors/Finishes

Color tiles intended for reference only.

Color	Code	Description
-------	------	-------------

	0	White
	96	Biscuit

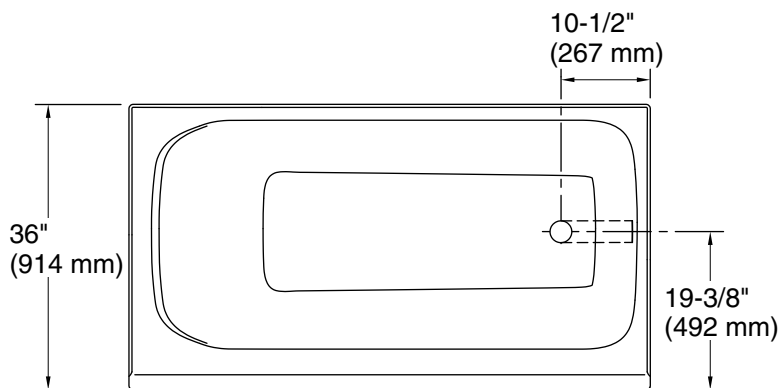

No change in measurements if connected with drain illustrated. (1381626)

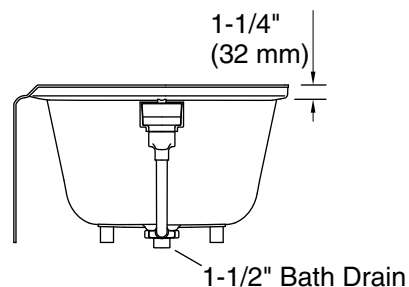
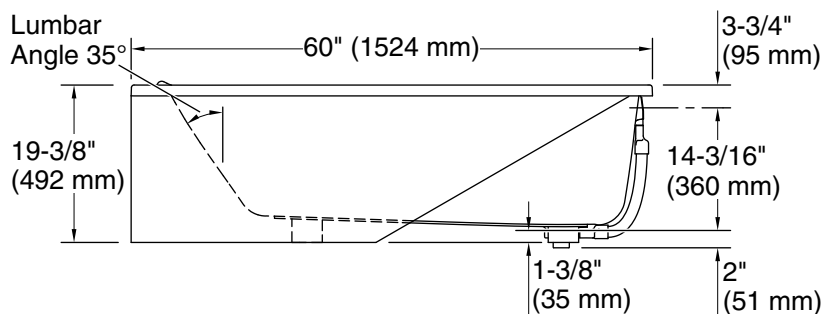
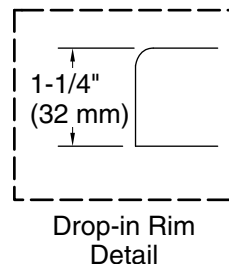

Technical Information

All product dimensions are nominal.

Drain location:	Right
Basin area, bottom:	43-1/2" x 24-7/8" (1105 mm x 632 mm)
Basin area, top:	55-15/16" x 29-1/2" (1421 mm x 749 mm)
Weight:	106.24 lbs (48.2 kg)
Water depth:	13-1/4" (337 mm)
Water capacity:	65.4 gal (247.6 L)
Minimum flat for door:	2-15/16" (75 mm)

Notes

Measure your actual product for rough-in details.

Install this product according to the installation instructions.

The hot water supply should be 70% of the capacity of the bath or greater. Installations will vary.

ADA compliant when installed to the specific requirements of these regulations.