

### Features

- Right-hand Polished Chrome trip lever.
- For use with the K-20450-RA Irvine™ toilet.

### Material

- Premium metal construction for durability and reliability.
- KOHLER finishes resist corrosion and tarnishing.

### Recommended Products/Accessories

K-23723 Faucet cleaner



ADA CSA B651 OBC

### Codes/Standards







ADA  
ICC/ANSI A117.1  
CSA B651  
OBC

### KOHLER® One-Year Limited Warranty

See website for detailed warranty information.

### Available Colors/Finishes

*Color tiles intended for reference only.*

Color	Code	Description
	CP	Polished Chrome
	SN	Vibrant® Polished Nickel
	BN	Vibrant® Brushed Nickel
	2BZ	Oil-Rubbed Bronze
	BL	Matte Black
	2MB	Vibrant® Brushed Moderne Brass

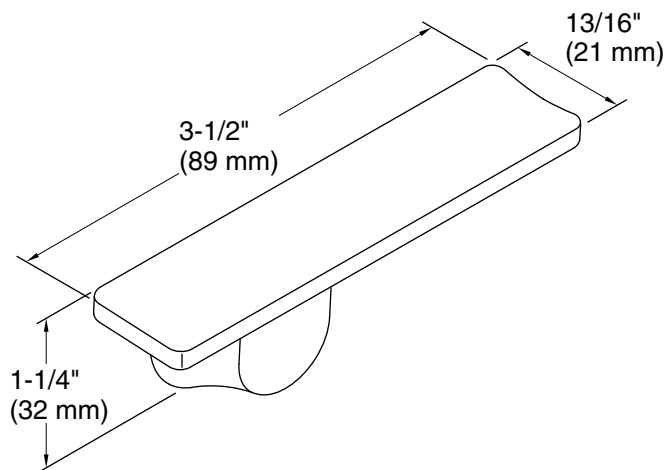

### Technical Information

All product dimensions are nominal.

Installation Type: Fixture-mount

Material: Metal

### Notes

ADA, OBC, CSA B651 compliant when installed to the specific requirements of these regulations.