

Features

- Bask® heated surface creates spa-like relaxation with soothing warmth on your back, shoulders, and neck.
- Three heat settings allow you to customize the surface temperature.
- 120 airjets release thousands of bubbles that surround, support, and massage the body.
- Variable-speed blower lets you adjust massage intensity to 18 levels.
- Comfort Depth® design offers a convenient 19-inch step-over height while retaining the same depth as a standard 21-inch bath.
- Molded lumbar support offers extra comfort while bathing.
- Slotted overflow allows for deep soaking.
- Textured bottom surface.
- Reversible drain.
- Coordinates with other products in the Archer collection.

Material

- Acrylic

Hydrotherapy

- BubbleMassage

Installation

- Drop-in

Additional Hydrotherapy Options

- Soaking Bath - K-1948-0
- Soaking Bath + Bask heated surface - K-1948-W1
- BubbleMassage air bath - K-1949-G
- BubbleMassage air bath + Bask heated surface - K-1949-GW
- VibrAcoustic - K-1949-VB
- VibrAcoustic + Bask heated surface - K-1949-VBW
- Whirlpool - K-1949-0
- Whirlpool + heater - K-1949-H
- Whirlpool + Bask heated surface - K-1949-W1
- Whirlpool + BubbleMassage air bath - K-1949-XHG

Required Products/Accessories

K-7271 Brass Slotted Overflow Bath Drain

or

K-7272 PVC Slotted Overflow Bath Drain

Recommended Products/Accessories

K-1446 Remote Installation Kit

K-24916 Wireless Music Kit



ADA

Codes/Standards









ASME A112.19.7/CSA B45.10
CSA B45.5/IAPMO Z124
UL 1795
CSA C22.2 No. 218.2
ADA
ICC/ANSI A117.1

**KOHLER® Plastic Baths and Receptors
Lifetime Limited Warranty
KOHLER® Hydrotherapy Components
Five-Year Limited Warranty**

See website for detailed warranty information.

Available Colors/Finishes

Color tiles intended for reference only.

| Color | Code | Description |
|--|------|---------------|
|  | 0 | White |
|  | 96 | Biscuit |
|  | 47 | Almond |
|  | NY | Dune |
|  | 95 | Ice™ Grey |
|  | G9 | Sandbar |
|  | K4 | Cashmere |
|  | 58 | Thunder™ Grey |
|  | 7 | Black Black™ |

No change in measurements if connected with drain illustrated. (K-7271 or K-7272)

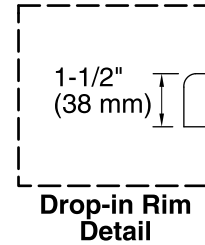
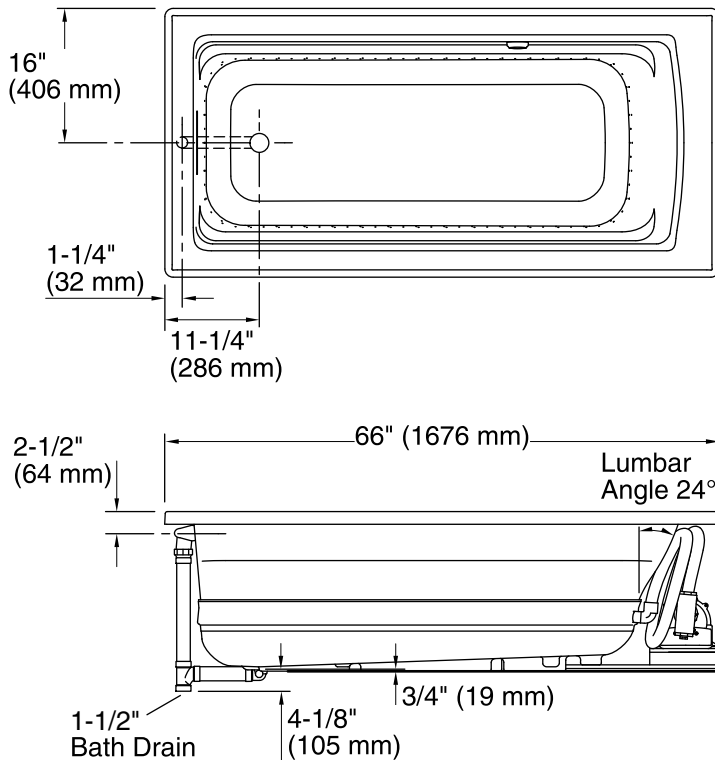

Blower Motor Access
20" (508 mm) W x 15" (381 mm) H

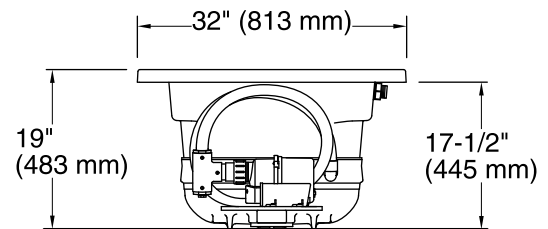

Required Electrical Service

One dedicated circuit required, protected with Class A Ground-Fault Circuit-Interrupter (GFCI). Outside North America, this device may be known as a Residual Current Device (RCD).

Blower, Heated 120 V, 15 A, 60 Hz
Surface:

Technical Information

All product dimensions are nominal.

| | |
|------------------------------|---|
| Installation: | Drop-in |
| Drain location: | End |
| Basin area, bottom: | 50-3/8" x 19-5/8" (1280 mm x 498 mm) |
| Basin area, top: | 57-5/16" x 24-1/16" (1456 mm x 611 mm) |
| Weight: | 95 lbs (43.1 kg) |
| Minimum floor load: | 45.7 lbs/ft ² (223.1 kg/m ²) |
| Water depth: | 15-5/16" (389 mm) |
| Water capacity: | 66 gal (249.8 L) |
| Cutout: | Drop-in, 64-1/2" x 30-1/2" (1638 mm x 775 mm) |
| Electrical component rating: | Blower: 120 V, 10 A, 60 Hz Heated Surface: 120 V, 0.5 A, 60 Hz, 65 W |

Notes

Measure your actual product for rough-in details. Install this product according to the installation instructions.

The hot water supply should be 70% of the capacity of the bath or greater. Installations will vary.

This product is designed for drop-in installation only. It is not suited for use in a three-wall alcove with an overhead shower.

Remote blower installation kit K-1446 is available for relocating the blower. Provide access for servicing the blower.

Do not relocate or alter the PVC tee or coiled flexible tubing connected to the blower. Follow the blower relocation instructions exactly.

ADA compliant when installed to the specific requirements of these regulations.