

### Features

- 120 airjets release thousands of bubbles that surround, support, and massage the body.
- Variable-speed blower lets you adjust massage intensity to 18 levels.
- Single-speed whirlpool offers performance and value, with 8 fully adjustable jets.
- Hydromassage flow and direction can be controlled at each jet.
- Built-in heater.
- Comfort Depth® design offers a convenient 19-inch step-over height while retaining the same depth as a standard 21-inch bath.
- Molded lumbar support offers extra comfort while bathing.
- Slotted overflow allows for deep soaking.
- Integral apron.
- Integral flange helps prevent water from seeping behind wall and simplifies alcove installation.
- Textured bottom surface.
- Right-hand drain.
- Coordinates with other products in the Archer collection.

### Material

- KOHLER ExoCrylic material offers 30% lighter product weight for easier installation.\*

### Hydrotherapy

- BubbleMassage
- Whirlpool

### Installation

- Three-wall alcove.

### Additional Hydrotherapy Options

- Soaking Bath - K-1946-RA
- Soaking Bath + Bask heated surface - K-1946-RAW
- BubbleMassage air bath - K-1947-GRA
- BubbleMassage air bath + Bask heated surface - K-1947-GRAW
- VibrAcoustic - K-1947-VBRA
- VibrAcoustic + Bask heated surface - K-1947-VBRAW
- Whirlpool - K-1947-RA
- Whirlpool + heater - K-1947-HRA
- Whirlpool + Bask heated surface - K-1947-RAW
- Whirlpool + BubbleMassage air bath - K-1947-XHGRA

### Required Products/Accessories

K-7271 Brass Slotted Overflow Bath Drain

or

K-7272 PVC Slotted Overflow Bath Drain



ADA

### Codes/Standards











ASME A112.19.7/CSA B45.10  
CSA B45.5/IAPMO Z124  
UL 1795  
ADA  
ICC/ANSI A117.1

**KOHLER® Plastic Baths and Receptors  
Lifetime Limited Warranty  
KOHLER® Hydrotherapy Components  
Five-Year Limited Warranty**

See website for detailed warranty information.

### Available Colors/Finishes

*Color tiles intended for reference only.*

Color	Code	Description
	0	White
	96	Biscuit
	47	Almond
	NY	Dune
	95	Ice™ Grey
	G9	Sandbar
	33	Mexican Sand™
	K4	Cashmere
	58	Thunder™ Grey
	7	Black Black™

No change in measurements if connected with drain illustrated. (K-7272)

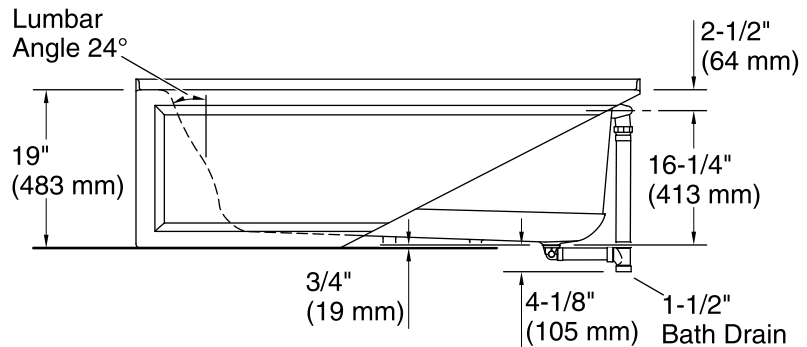
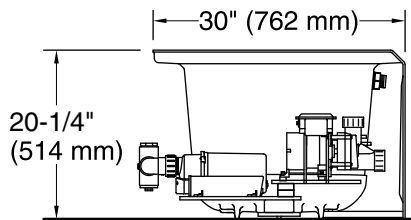
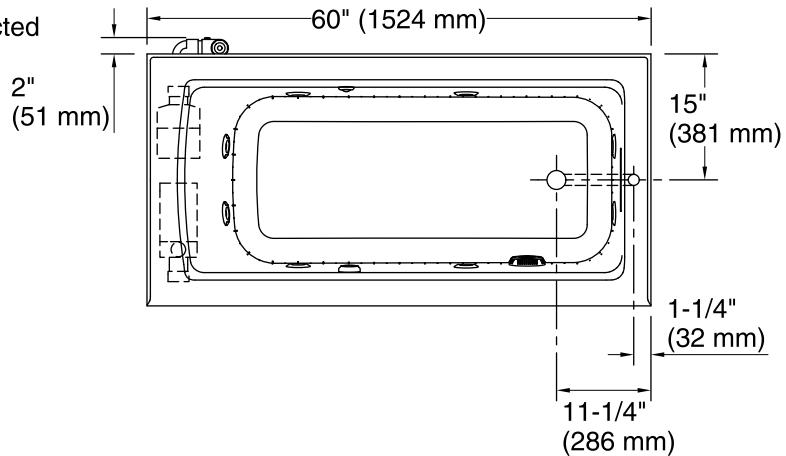
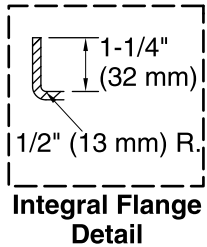

### Required Electrical Service

Three dedicated circuits required, protected with Class A Ground-Fault Circuit-Interrupter (GFCI). Outside North America, this device may be known as a Residual Current Device (RCD).

Blower:	120 V, 15 A, 60 Hz
Pump:	120 V, 15 A, 60 Hz
Heater:	120 V, 15 A, 60 Hz

### Technical Information

All product dimensions are nominal.

Installation:	Three-wall alcove
Drain location:	Right
Basin area, bottom:	45-1/8" x 19-11/16" (1146 mm x 500 mm)
Basin area, top:	52-1/8" x 22-1/16" (1324 mm x 560 mm)
Weight:	153 lbs (69.4 kg)
Minimum floor load:	51.3 lbs/ft <sup>2</sup> (250.5 kg/m <sup>2</sup> )
Water depth:	15-1/8" (384 mm)
Water capacity:	57 gal (215.8 L)
Electrical component rating:	Blower: 120 V, 10 A, 60 Hz Pump: 120 V, 7 A, 60 Hz Heater: 120 V, 12.5 A, 60 Hz, 1500 W
Pump speed:	Single

### Notes

Measure your actual product for rough-in details. Install this product according to the installation instructions.

The hot water supply should be 70% of the capacity of the bath or greater. Installations will vary.

ADA compliant when installed to the specific requirements of these regulations.