

### Features

- 120 airjets release thousands of bubbles that surround, support, and massage the body.
- Variable-speed blower lets you adjust massage intensity to 18 levels.
- Single-speed whirlpool offers performance and value, with 8 fully adjustable jets.
- Hydromassage flow and direction can be controlled at each jet.
- Built-in heater.
- Comfort Depth® design offers a convenient 19-inch step-over height while retaining the same depth as a standard 21-inch bath.
- Molded lumbar support offers extra comfort while bathing.
- Slotted overflow allows for deep soaking.
- Integral flange helps prevent water from seeping behind wall and simplifies alcove installation.
- Textured bottom surface.
- Left-hand drain.
- Coordinates with other products in the Archer collection.

### Material

- KOHLER ExoCrylic material offers 30% lighter product weight for easier installation.\*

### Hydrotherapy

- BubbleMassage
- Whirlpool

### Installation

- Three-wall alcove.

### Additional Hydrotherapy Options

- Soaking Bath - K-1946-L
- Soaking Bath + Bask heated surface - K-1946-LW
- BubbleMassage air bath - K-1947-GLF
- BubbleMassage air bath + Bask heated surface - K-1947-GLW
- VibrAcoustic - K-1947-VBL
- VibrAcoustic + Bask heated surface - K-1947-VBLW
- Whirlpool - K-1947-L
- Whirlpool + heater - K-1947-LH
- Whirlpool + Bask heated surface - K-1947-LW
- Whirlpool + BubbleMassage air bath - K-1947-XHGL

### Required Products/Accessories

K-7271 Brass Slotted Overflow Bath Drain

or

K-7272 PVC Slotted Overflow Bath Drain

### Recommended Products/Accessories

K-24916 Wireless Music Kit



ADA

### Codes/Standards











ASME A112.19.7/CSA B45.10  
CSA B45.5/IAPMO Z124  
UL 1795  
ADA  
ICC/ANSI A117.1

**KOHLER® Plastic Baths and Receptors  
Lifetime Limited Warranty  
KOHLER® Hydrotherapy Components  
Five-Year Limited Warranty**

See website for detailed warranty information.

### Available Colors/Finishes

*Color tiles intended for reference only.*

| Color  | Code | Description   |
|--|------|---------------|
|  | 0    | White         |
|  | 96   | Biscuit       |
|  | 47   | Almond        |
|  | NY   | Dune          |
|  | 95   | Ice™ Grey     |
|  | G9   | Sandbar       |
|  | 33   | Mexican Sand™ |
|  | K4   | Cashmere      |
|  | 58   | Thunder™ Grey |
|  | 7    | Black Black™  |

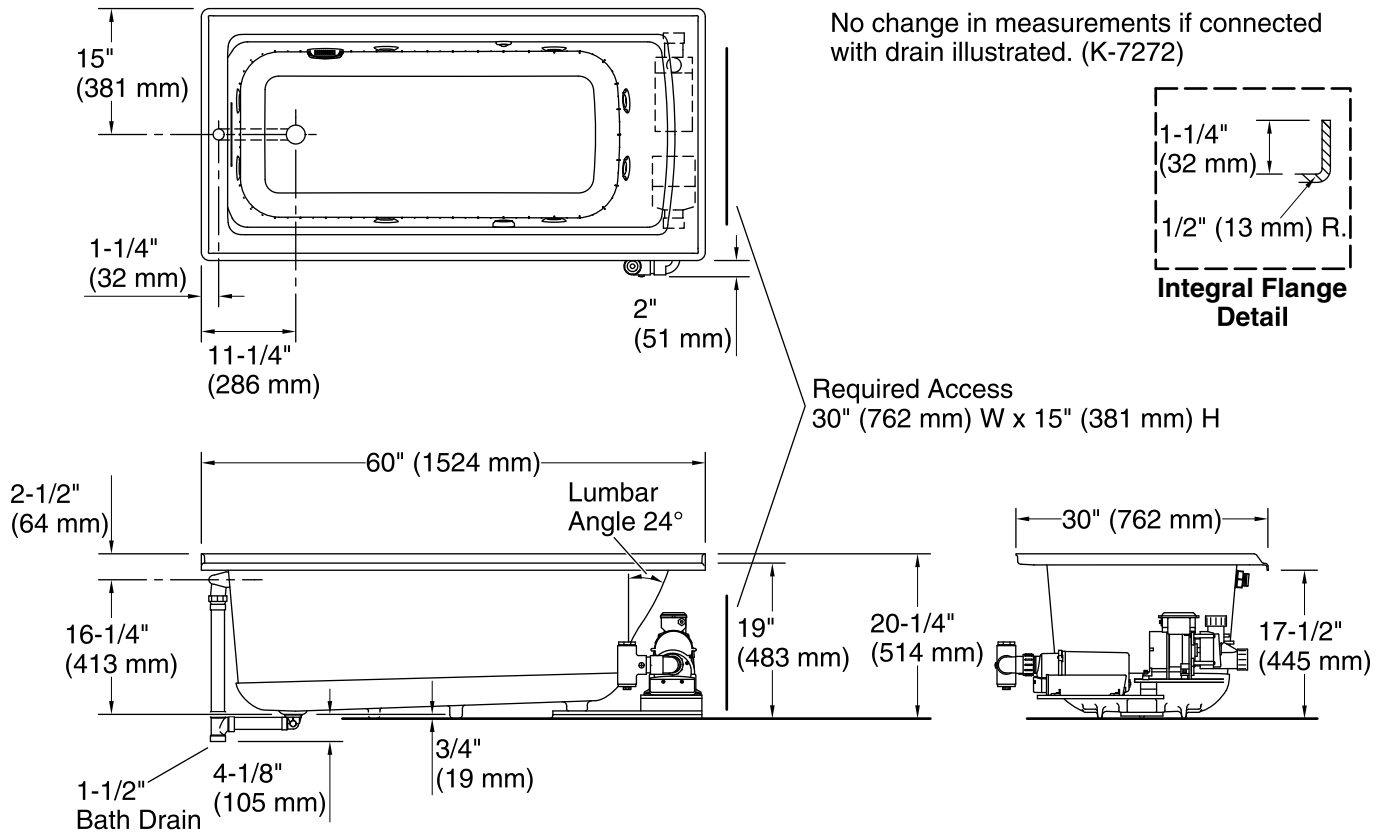

### Required Electrical Service

Three dedicated circuits required, protected with Class A Ground-Fault Circuit-Interrupter (GFCI). Outside North America, this device may be known as a Residual Current Device (RCD).

|         |                    |
|---------|--------------------|
| Blower: | 120 V, 15 A, 60 Hz |
| Pump:   | 120 V, 15 A, 60 Hz |
| Heater: | 120 V, 15 A, 60 Hz |

### Technical Information

All product dimensions are nominal.

|                              |   |
|------------------------------|---|
| Installation:                | Three-wall alcove   |
| Drain location:              | Left  |
| Basin area, bottom:          | 45-1/8" x 19-11/16" (1146 mm x 500 mm)  |
| Basin area, top:             | 52-1/8" x 22-1/16" (1324 mm x 560 mm)   |
| Weight:                      | 138 lbs (62.6 kg)   |
| Minimum floor load:          | 51.3 lbs/ft <sup>2</sup> (250.5 kg/m <sup>2</sup> )   |
| Water depth:                 | 15-1/8" (384 mm)  |
| Water capacity:              | 57 gal (215.8 L)  |
| Electrical component rating: | Blower: 120 V, 10 A, 60 Hz<br>Pump: 120 V, 7 A, 60 Hz<br>Heater: 120 V, 12.5 A, 60 Hz, 1500 W |
| Pump speed:                  | Single  |

### Notes

Measure your actual product for rough-in details. Install this product according to the installation instructions.

The hot water supply should be 70% of the capacity of the bath or greater. Installations will vary.

ADA compliant when installed to the specific requirements of these regulations.