

Features

- VibrAcoustic calms and soothes with sound vibration technology.
- Six concealed speakers send sound waves through the water to gently massage the body.
- Four original instrumental compositions offer different levels of relaxation.
- Syncs with devices enabled with BLUETOOTH® wireless technology including smartphones, MP3 players, tablets, and laptops located up to 33 feet away.*
- Customize your experience with the high-resolution color touch screen.
- Fully adjustable volume above and below the water.
- Functions as a hydrotherapy bath when full of water and a stereo system when empty.
- Bask® heated surface creates spa-like relaxation with soothing warmth on your back and neck.
- Three heat settings allow you to customize the surface temperature.
- Comfort Depth® design offers a convenient 19-inch step-over height while retaining the same depth as a standard 21-inch bath.
- Molded lumbar support offers extra comfort while bathing.
- Slotted overflow allows for deep soaking.
- Textured bottom surface.
- Integral flange helps prevent water from seeping behind wall and simplifies alcove installation.
- Right-hand drain.
- Includes 25 feet of wiring and amplifier.

Material

- Acrylic

Hydrotherapy

- VibrAcoustic

Installation

- Three-wall alcove.
- Requires 110V electrical service.

Additional Hydrotherapy Options

- Soaking Bath - K-1946-R
- Soaking Bath + Bask heated surface - K-1946-RW
- BubbleMassage air bath - K-1947-GRF
- BubbleMassage air bath + Bask heated surface - K-1947-GRW
- VibrAcoustic - K-1947-VBR
- VibrAcoustic + Bask heated surface - K-1947-VBRW
- Whirlpool - K-1947-R
- Whirlpool + heater - K-1947-RH
- Whirlpool + Bask heated surface - K-1947-RW



ADA

Codes/Standards









CSA B45.5/IAPMO Z124
UL 1795
ADA
ICC/ANSI A117.1

KOHLER® Plastic Baths and Receptors Lifetime Limited Warranty

See website for detailed warranty information.

Available Colors/Finishes

Color tiles intended for reference only.

Color	Code	Description
	0	White
	96	Biscuit
	47	Almond
	NY	Dune
	95	Ice™ Grey
	G9	Sandbar
	K4	Cashmere
	58	Thunder™ Grey
	7	Black Black™

No change in measurements if connected with drain illustrated. (K-7272)

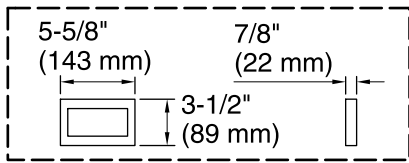

User Interface

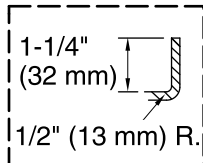

Integral Flange Detail

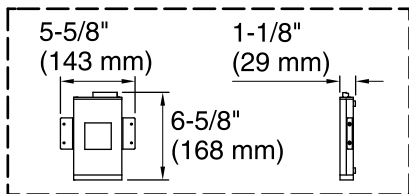

Amplifier

Control Access
30" (762 mm) W x
15" (381 mm) H

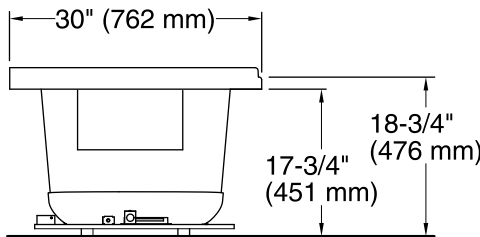

***Recommended User Interface Location**

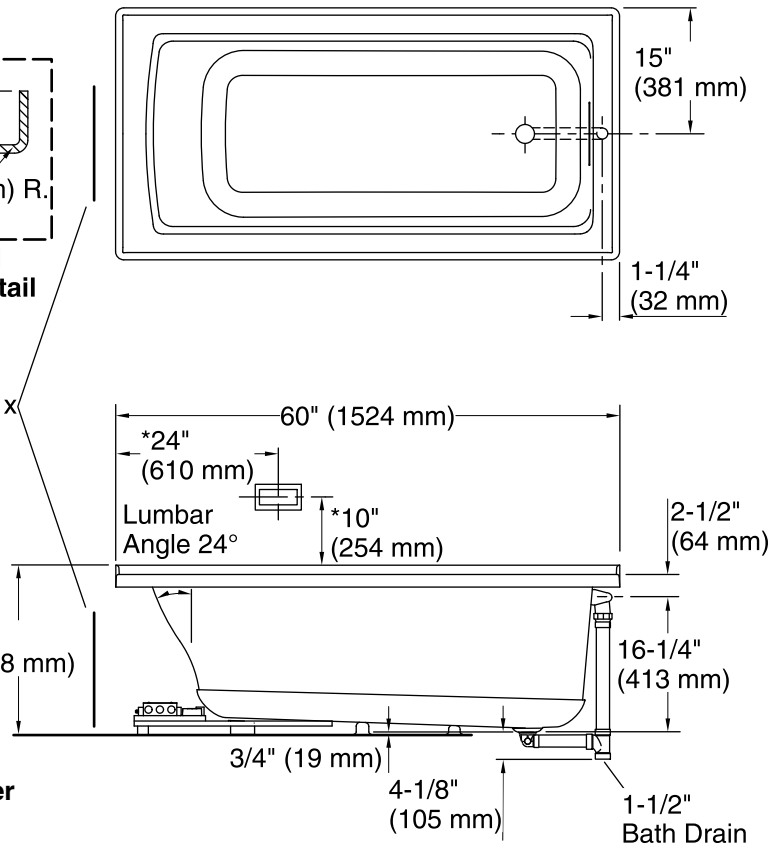

Required Electrical Service

One circuit required, protected with Class A Ground-Fault Circuit-Interrupter (GFCI). Outside North America, this device may be known as a Residual Current Device (RCD).

Amplifier, Heated 120 V, 15 A, 50/60 Hz
Surface:

Technical Information

All product dimensions are nominal.

Installation:	Three-wall alcove
Drain location:	Right
Basin area, bottom:	45-1/8" x 19-11/16" (1146 mm x 500 mm)
Basin area, top:	52-1/8" x 22-1/16" (1324 mm x 560 mm)
Weight:	80 lbs (36.3 kg)
Minimum floor load:	47 lbs/ft ² (229.5 kg/m ²)
Water depth:	15-1/8" (384 mm)
Water capacity:	57 gal (215.8 L)
Electrical component rating:	Amplifier: 120 V, 50/60 Hz Heated Surface: 120 V, 0.5 A, 50/60 Hz, 65 W
Minimum flat for door:	2" (51 mm)
Bluetooth® range:	33 ft (0.8 m)

Notes

Measure your actual product for rough-in details. Install this product according to the installation instructions.

The hot water supply should be 70% of the capacity of the bath or greater. Installations will vary.

Control amplifier fits 16" (406 mm) center studs. 25' (7.6 m) cables are included.

ADA compliant when installed to the specific requirements of these regulations.