

### Features

- VibrAcoustic calms and soothes with sound vibration technology.
- Six concealed speakers send sound waves through the water to gently massage the body.
- Four original instrumental compositions offer different levels of relaxation.
- Syncs with devices enabled with BLUETOOTH® wireless technology including smartphones, MP3 players, tablets, and laptops located up to 33 feet away.\*
- Customize your experience with the high-resolution color touch screen.
- Fully adjustable volume above and below the water.
- Functions as a hydrotherapy bath when full of water and a stereo system when empty.
- Includes 25 feet of wiring and amplifier.
- Comfort Depth® design offers a convenient 19-inch step-over height while retaining the same depth as a standard 21-inch bath.
- Molded lumbar support offers extra comfort while bathing.
- Slotted overflow allows for deep soaking.
- Integral apron.
- Integral flange helps prevent water from seeping behind wall and simplifies alcove installation.
- Textured bottom surface.
- Left-hand drain.

### Material

- KOHLER ExoCrylic material offers 30% lighter product weight for easier installation.\*

### Hydrotherapy

- VibrAcoustic

### Installation

- Three-wall alcove.
- Requires 110V electrical service.

### Additional Hydrotherapy Options

- Soaking Bath - K-1946-LA
- Soaking Bath + Bask heated surface - K-1946-LAW
- BubbleMassage air bath - K-1947-GLA
- BubbleMassage air bath + Bask heated surface - K-1947-GLAW
- VibrAcoustic - K-1947-VBLA
- VibrAcoustic + Bask heated surface - K-1947-VBLAW
- Whirlpool - K-1947-LA
- Whirlpool + heater - K-1947-HLA
- Whirlpool + Bask heated surface - K-1947-LAW
- Whirlpool + BubbleMassage air bath - K-1947-XHGLA



ADA

### Codes/Standards

CSA B45.5/IAPMO Z124  
UL 1795  
ADA  
ICC/ANSI A117.1











### KOHLER® Plastic Baths and Receptors Lifetime Limited Warranty

See website for detailed warranty information.

The BLUETOOTH® word mark and logos are registered trademarks owned by Bluetooth SIG, Inc. and any use of such marks by Kohler Co. is under license. Other trademarks and trade names are those of their respective owners.

### Available Colors/Finishes

*Color tiles intended for reference only.*

Color	Code	Description
	0	White
	96	Biscuit
	47	Almond
	NY	Dune
	95	Ice™ Grey
	G9	Sandbar
	33	Mexican Sand™
	K4	Cashmere
	58	Thunder™ Grey
	7	Black Black™

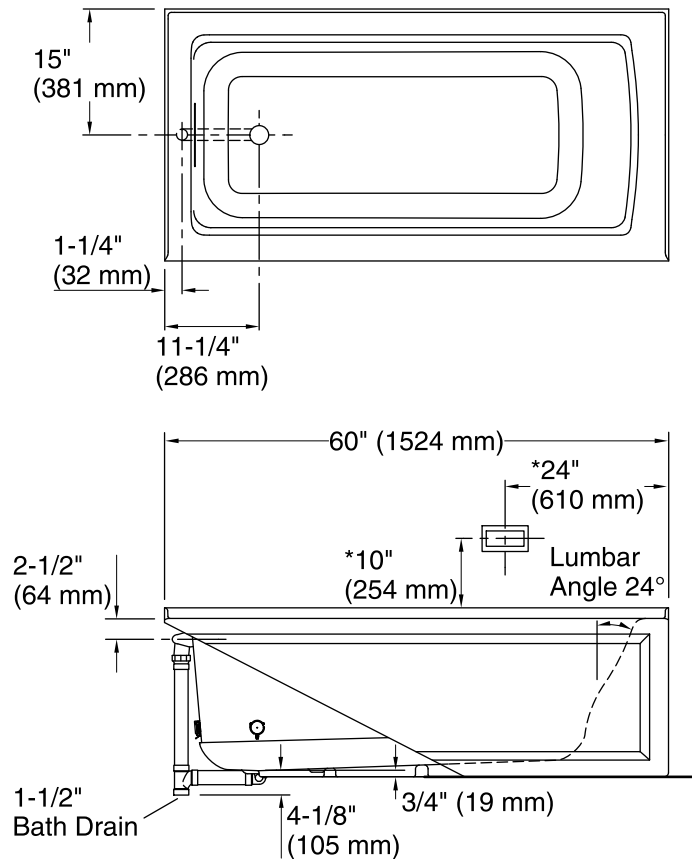

No change in measurements if connected with drain illustrated. (K-7272)

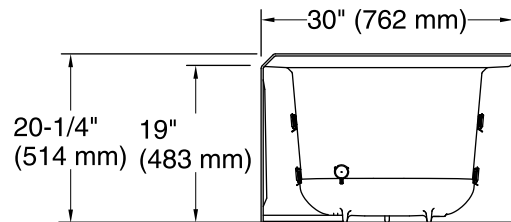
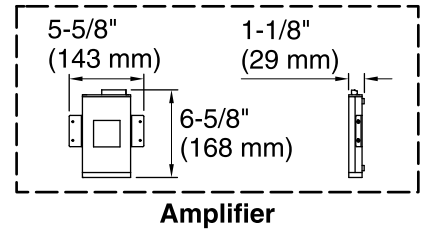
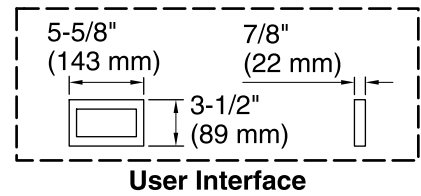
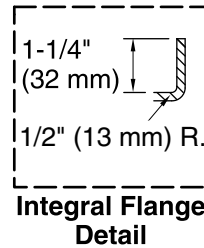

### Required Electrical Service

One circuit required, protected with Class A Ground-Fault Circuit-Interrupter (GFCI). Outside North America, this device may be known as a Residual Current Device (RCD).

Amplifier: 120 V, 15 A, 50/60 Hz

### Technical Information

All product dimensions are nominal.

- Installation: Three-wall alcove
- Drain location: Left
- Basin area, bottom: 45-1/8" x 19-11/16" (1146 mm x 500 mm)
- Basin area, top: 52-1/8" x 22-1/16" (1324 mm x 560 mm)
- Weight: 76 lbs (34.5 kg)
- Minimum floor load: 47 lbs/ft² (229.5 kg/m²)
- Water depth: 15-1/8" (384 mm)
- Water capacity: 57 gal (215.8 L)
- Electrical component rating: Amplifier: 120 V, 1.1 A, 50/60 Hz
- Amplifier channels: 2 at 15 W per channel, 2 at 30 W per channel
- Minimum flat for door: 2" (51 mm)
- Bluetooth® range: 33 ft (0.8 m)

### Notes

Measure your actual product for rough-in details. Install this product according to the installation instructions.

The hot water supply should be 70% of the capacity of the bath or greater. Installations will vary.

Control amplifier fits 16" (406 mm) center studs. 25' (7.6 m) cables are included.

ADA compliant when installed to the specific requirements of these regulations.