

Features

- Comfort Depth® design offers a convenient 19-inch step-over height while retaining the same depth as a standard 21-inch bath.
- Molded lumbar support offers extra comfort while bathing.
- Slotted overflow allows for deep soaking.
- Integral flange helps prevent water from seeping behind wall and simplifies alcove installation.
- Textured bottom surface
- Left-hand drain.
- Coordinates with other products in the Archer collection.

Material

- Acrylic

Installation

- Three-wall alcove.

Additional Hydrotherapy Options

- Soaking Bath - K-1946-L
- Soaking Bath + Bask heated surface - K-1946-LW
- BubbleMassage air bath - K-1947-GLF
- BubbleMassage air bath + Bask heated surface - K-1947-GLW
- VibrAcoustic - K-1947-VBL
- VibrAcoustic + Bask heated surface - K-1947-VBLW
- Whirlpool - K-1947-L
- Whirlpool + heater - K-1947-LH
- Whirlpool + Bask heated surface - K-1947-LW
- Whirlpool + BubbleMassage air bath - K-1947-XHGL

Required Products/Accessories

K-7271 Brass Slotted Overflow Bath Drain

or

K-7272 PVC Slotted Overflow Bath Drain

Recommended Products/Accessories

K-24916 Wireless Music Kit



ADA

Codes/Standards

CSA B45.5/IAPMO Z124

ADA









ICC/ANSI A117.1

KOHLER® Plastic Baths and Receptors Lifetime Limited Warranty

See website for detailed warranty information.

Available Colors/Finishes

Color tiles intended for reference only.

Color	Code	Description
	0	White
	96	Biscuit
	47	Almond
	NY	Dune
	95	Ice™ Grey
	G9	Sandbar
	K4	Cashmere
	58	Thunder™ Grey
	7	Black Black™

No change in measurements if connected with drain illustrated. (K-7272)

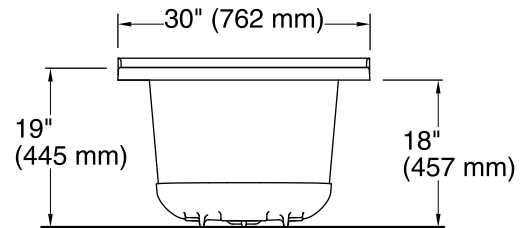
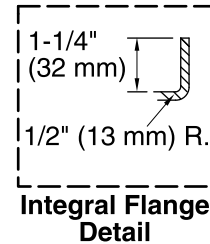
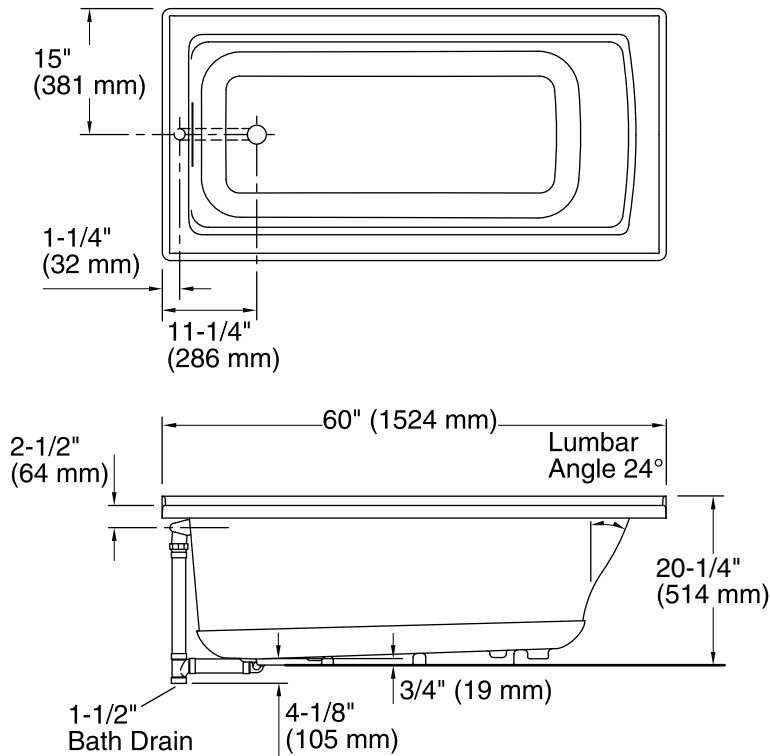

Technical Information

All product dimensions are nominal.

Installation:	Three-wall alcove
Drain location:	Left
Basin area, bottom:	45-1/8" x 19-11/16" (1146 mm x 500 mm)
Basin area, top:	52-1/8" x 22-1/16" (1324 mm x 560 mm)
Weight:	58 lbs (26.3 kg)
Minimum floor load:	45 lbs/ft ² (219.7 kg/m ²)
Water depth:	15-1/8" (384 mm)
Water capacity:	57 gal (215.8 L)
Minimum flat for door:	2" (51 mm)

Notes

Measure your actual product for rough-in details. Install this product according to the installation instructions.

The hot water supply should be 70% of the capacity of the bath or greater. Installations will vary.

ADA compliant when installed to the specific requirements of these regulations.