

Features

- VibrAcoustic calms and soothes with sound vibration technology.
- Six concealed speakers send sound waves through the water to gently massage the body.
- Four original instrumental compositions offer different levels of relaxation.
- Syncs with devices enabled with BLUETOOTH® wireless technology including smartphones, MP3 players, tablets, and laptops located up to 33 feet away.*
- Customize your experience with the high-resolution color touch screen.
- Fully adjustable volume above and below the water.
- Functions as a hydrotherapy bath when full of water and a stereo system when empty.
- Bask® heated surface creates spa-like relaxation with soothing warmth on your back and neck.
- Three heat settings allow you to customize the surface temperature.
- Chromatherapy lighting allows you to select a preferred color scheme to suit your mood.
- Clearflo slotted overflow for deep soaking.
- Includes 25 feet of wiring and amplifier.

Material

- Acrylic

Hydrotherapy

- VibrAcoustic
- Chromatherapy

Installation

- Drop-in or under-mount.
- Requires 110V electrical service.

Additional Hydrotherapy Options

- Soaking Bath - K-1848-0
- Soaking Bath + Bask heated surface - K-1848-W1
- BubbleMassage air bath - K-1849-G
- BubbleMassage air bath + chromatherapy - K-1849-GCR
- VibrAcoustic + BubbleMassage air bath - K-1849-GVB
- VibrAcoustic + BubbleMassage air bath + Bask heated surface + chromatherapy - K-1849-GVBCW
- BubbleMassage air bath + Bask heated surface - K-1849-GW
- Whirlpool + heater - K-1849-H2
- VibrAcoustic - K-1849-VB
- VibrAcoustic + chromatherapy - K-1849-VBC
- VibrAcoustic + chromatherapy + Bask heated surface - K-1849-VBCW
- VibrAcoustic + Bask heated surface - K-1849-VBW



Codes/Standards









CSA B45.5/IAPMO Z124
ASTM E162
ASTM E662
UL 1795
CSA C22.2 No. 218.2

KOHLER® Plastic Baths and Receptors Lifetime Limited Warranty

See website for detailed warranty information.

Available Colors/Finishes

Color tiles intended for reference only.

Color	Code	Description
	0	White
	96	Biscuit
	47	Almond
	NY	Dune
	95	Ice™ Grey
	G9	Sandbar
	K4	Cashmere
	58	Thunder™ Grey
	7	Black Black™

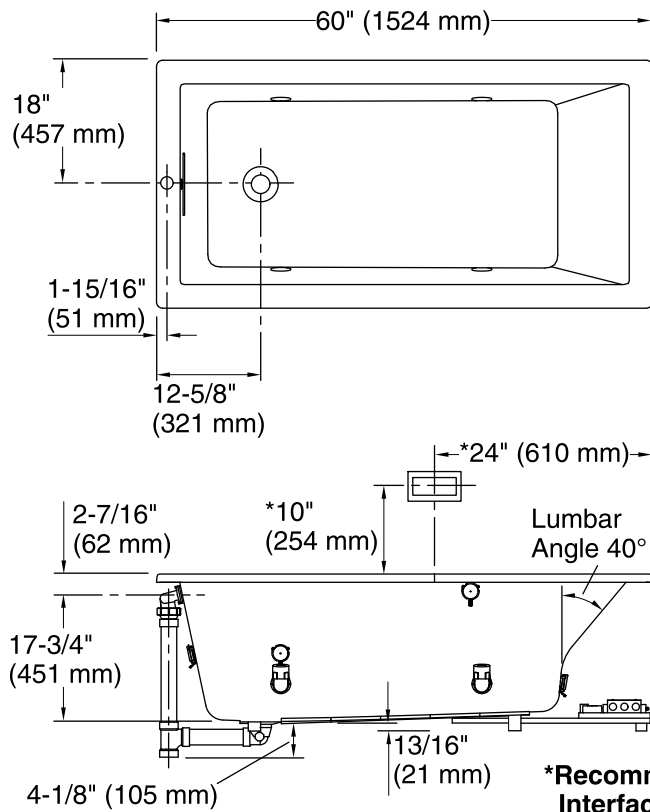

No change in measurement if connected with drain illustrated. (K-7272)

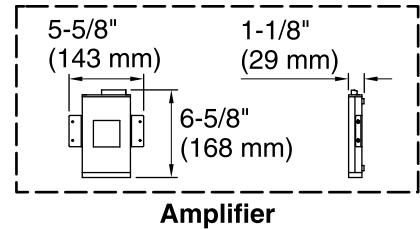
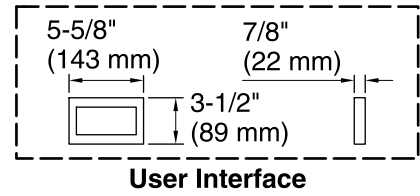
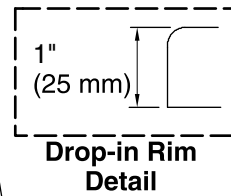

Control Access
30" (762 mm) W
x 15" (381 mm) H
Min

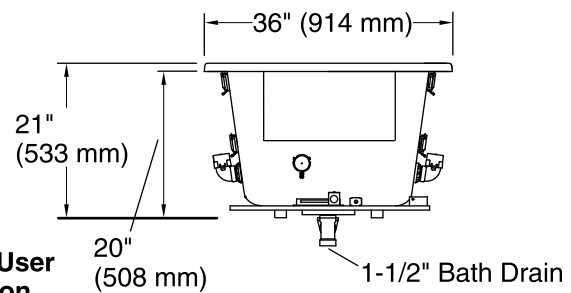

***Recommended User Interface Location**

Required Electrical Service

One circuit required, protected with Class A Ground-Fault Circuit-Interrupter (GFCI). Outside North America, this device may be known as a Residual Current Device (RCD).

Amplifier, Heated Surface: 120 V, 15 A, 50/60 Hz

Technical Information

All product dimensions are nominal.

Installation:	Drop-in, Under-mount
Drain location:	End
Basin area, bottom:	39-9/16" x 24-11/16" (1005 mm x 627 mm)
Basin area, top:	53-5/8" x 29-1/2" (1362 mm x 749 mm)
Weight:	85 lbs (38.6 kg)
Minimum floor load:	52 lbs/ft ² (253.9 kg/m ²)
Water depth:	17-1/8" (435 mm)
Water capacity:	81 gal (306.6 L)
Cutout:	Drop-in, 59-1/2" x 35-1/2" (1511 mm x 902 mm)
Electrical component rating:	Amplifier: 120 V, 50/60 Hz Heated Surface: 120 V, 0.5 A, 50/60 Hz, 65 W

Notes

Measure your actual product for rough-in details. Install this product according to the installation instructions.

The hot water supply should be 70% of the capacity of the bath or greater. Installations will vary.

Control amplifier fits 16" (406 mm) center studs. 25' (7.6 m) cables are included.