

### Features

- VibrAcoustic calms and soothes with sound vibration technology.
- Six concealed speakers send sound waves through the water to gently massage the body.
- Four original instrumental compositions offer different levels of relaxation.
- Syncs with devices enabled with BLUETOOTH® wireless technology including smartphones, MP3 players, tablets, and laptops located up to 33 feet away.\*
- Customize your experience with the high-resolution color touch screen.
- Fully adjustable volume above and below the water.
- Functions as a hydrotherapy bath when full of water and a stereo system when empty.
- 122 airjets release thousands of bubbles that surround, support, and massage the body.
- Variable-speed blower lets you adjust massage intensity to 18 levels.
- Zones of Control feature allows you to target massage to back, midsection, or feet.
- Molded lumbar support offers extra comfort while bathing.
- Clearflo slotted overflow for deep soaking.
- Includes 25 feet of wiring and amplifier.
- Immediate and manual purge cycles remove residual water from air channels after use.
- Requires K-7271 or K-7272 Clearflo slotted overflow bath drain (sold separately).
- End drain.

### Material

- Acrylic

### Hydrotherapy

- VibrAcoustic
- BubbleMassage

### Installation

- Drop-in or under-mount.

### Additional Hydrotherapy Options

- Soaking Bath - K-1848-0
- Soaking Bath + Bask heated surface - K-1848-W1
- BubbleMassage air bath - K-1849-G
- BubbleMassage air bath + chromatherapy - K-1849-GCR
- VibrAcoustic + BubbleMassage air bath - K-1849-GVB
- VibrAcoustic + BubbleMassage air bath + Bask heated surface + chromatherapy - K-1849-GVBCW
- BubbleMassage air bath + Bask heated surface - K-1849-GW
- Whirlpool + heater - K-1849-H2



### Codes/Standards

ASME A112.19.7/CSA B45.10  
CSA B45.5/IAPMO Z124  
ASTM E162  
ASTM E662  
UL 1795  
CSA C22.2 No. 218.2









### KOHLER® Plastic Baths and Receptors Lifetime Limited Warranty KOHLER® Hydrotherapy Components Five-Year Limited Warranty

See website for detailed warranty information.

The BLUETOOTH® word mark and logos are registered trademarks owned by Bluetooth SIG, Inc. and any use of such marks by Kohler Co. is under license. Other trademarks and trade names are those of their respective owners.

### Available Colors/Finishes

*Color tiles intended for reference only.*

Color	Code	Description
	0	White
	96	Biscuit
	47	Almond
	NY	Dune
	95	Ice™ Grey
	G9	Sandbar
	K4	Cashmere
	58	Thunder™ Grey
	7	Black Black™

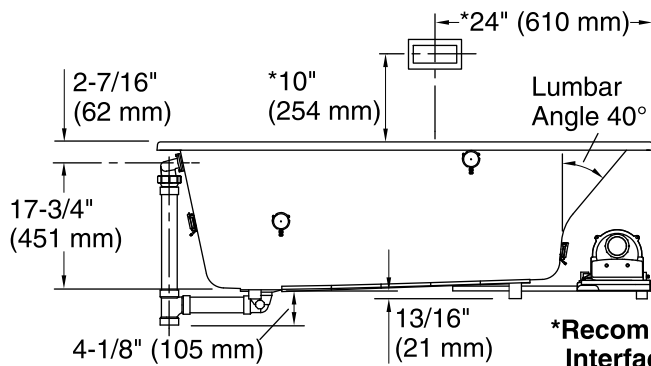
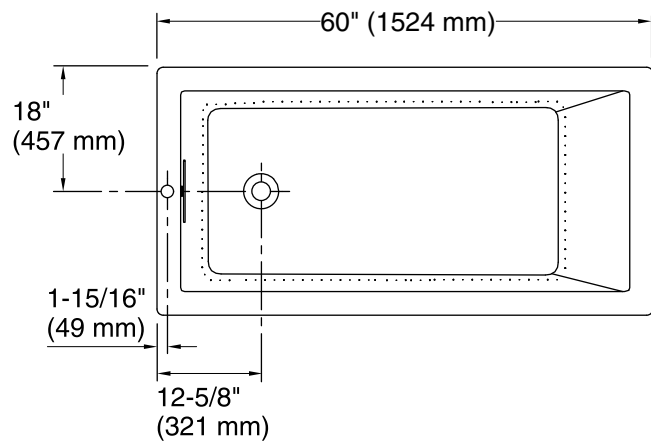

No change in measurement if connected with drain illustrated. (K-7272)

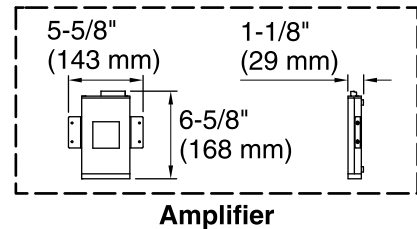
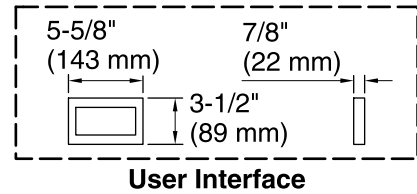
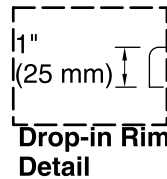

Control Access  
30" (762 mm) W  
x 15" (381 mm) H  
Min

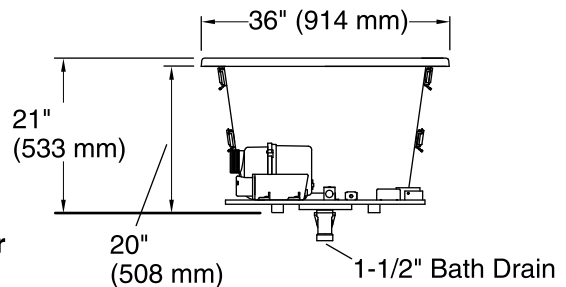

### Required Electrical Service

One dedicated circuit required, protected with Class A Ground-Fault Circuit-Interrupter (GFCI). Outside North America, this device may be known as a Residual Current Device (RCD).

Blower, Amplifier: 120 V, 15 A, 60 Hz

### Technical Information

All product dimensions are nominal.

Installation:	Drop-in, Under-mount
Drain location:	End
Basin area, bottom:	39-9/16" x 24-11/16" (1005 mm x 627 mm)
Basin area, top:	53-5/8" x 29-1/2" (1362 mm x 749 mm)
Weight:	110 lbs (49.9 kg)
Minimum floor load:	52.1 lbs/ft <sup>2</sup> (254.4 kg/m <sup>2</sup> )
Water depth:	17-1/8" (435 mm)
Water capacity:	81.1 gal (307 L)
Cutout:	Drop-in, 59-1/2" x 35-1/2" (1511 mm x 902 mm)
Electrical component rating:	Blower: 120 V, 10 A, 60 Hz Amplifier: 120 V, 1.1 A, 50/60 Hz
Amplifier channels:	2 at 15 W per channel 2 at 30 W per channel

### Notes

Measure your actual product for rough-in details. Install this product according to the installation instructions.

The hot water supply should be 70% of the capacity of the bath or greater. Installations will vary.

Provide one grounded electrical outlet within 24" (610 mm) of each component.

Control amplifier fits 16" (406 mm) center studs. 25' (7.6 m) cables are included.

Remote blower installation kit K-1446 is available for relocating the blower. Provide access for servicing the blower.

Do not relocate or alter the PVC tee or coiled flexible tubing connected to the blower. Follow the blower relocation instructions exactly.