

### Features

- VibrAcoustic calms and soothes with sound vibration technology.
- Six concealed speakers send sound waves through the water to gently massage the body.
- Four original instrumental compositions offer different levels of relaxation.
- Syncs with devices enabled with BLUETOOTH® wireless technology including smartphones, MP3 players, tablets, and laptops located up to 33 feet away.\*
- Customize your experience with the high-resolution color touch screen.
- Fully adjustable volume above and below the water.
- Functions as a hydrotherapy bath when full of water and a stereo system when empty.
- Bask® heated surface creates spa-like relaxation with soothing warmth on your back and neck.
- Three heat settings allow you to customize the surface temperature.
- Generous 6-foot length provides an incredibly spacious bathing area.
- Clearflo slotted overflow for deep soaking.
- Includes 25 feet of wiring and amplifier.

### Material

- Acrylic

### Hydrotherapy

- VibrAcoustic

### Installation

- Drop-in or under-mount.
- Requires 110V electrical service.

### Additional Hydrotherapy Options

- Soaking Bath - K-1834-0
- Soaking Bath + Bask heated surface - K-1834-W1
- BubbleMassage air bath - K-1835-G
- BubbleMassage air bath + chromatherapy - K-1835-GCR
- VibrAcoustic + BubbleMassage air bath - K-1835-GVB
- VibrAcoustic + BubbleMassage air bath + Bask heated surface + chromatherapy - K-1835-GVBCW
- BubbleMassage air bath + Bask heated surface - K-1835-GW
- Whirlpool + heater - K-1835-H2
- VibrAcoustic - K-1835-VB
- VibrAcoustic + chromatherapy - K-1835-VBC
- VibrAcoustic + chromatherapy + Bask heated surface - K-1835-VBCW
- VibrAcoustic + Bask heated surface - K-1835-VBW
- Whirlpool + BubbleMassage air bath - K-1835-XH2G



### Codes/Standards









ASME A112.19.7/CSA B45.10  
CSA B45.5/IAPMO Z124  
ASTM E162  
ASTM E662  
UL 1795  
CSA C22.2 No. 218.2

### KOHLER® Plastic Baths and Receptors Lifetime Limited Warranty

See website for detailed warranty information.

### Available Colors/Finishes

*Color tiles intended for reference only.*

Color	Code	Description
	0	White
	96	Biscuit
	47	Almond
	NY	Dune
	95	Ice™ Grey
	G9	Sandbar
	K4	Cashmere
	58	Thunder™ Grey
	7	Black Black™

No change in measurements if connected with required drain illustrated. (K-7272)

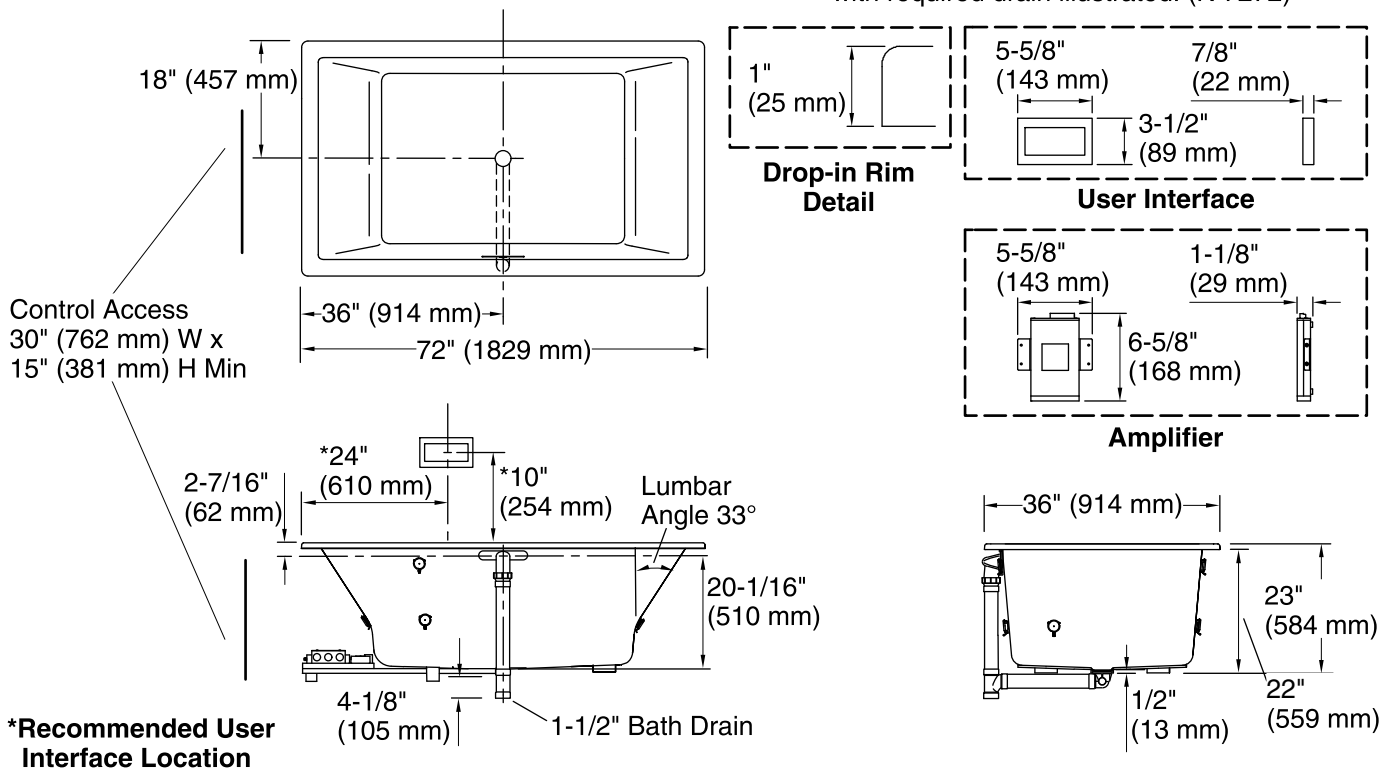

### Required Electrical Service

One circuit required, protected with Class A Ground-Fault Circuit-Interrupter (GFCI). Outside North America, this device may be known as a Residual Current Device (RCD).

Amplifier, Heated Surface: 120 V, 15 A, 50/60 Hz

### Technical Information

All product dimensions are nominal.

Installation:	Drop-in, Under-mount
Drain location:	Center
Basin area, bottom:	45-3/4" x 25-15/16" (1162 mm x 659 mm)
Basin area, top:	65-3/8" x 29-5/16" (1661 mm x 745 mm)
Weight:	92 lbs (41.7 kg)
Minimum floor load:	59 lbs/ft <sup>2</sup> (288.1 kg/m <sup>2</sup> )
Water depth:	19-7/16" (494 mm)
Water capacity:	112 gal (424 L)
Cutout:	Drop-in, 71-1/2" x 35-1/2" (1816 mm x 902 mm)
Electrical component rating:	Amplifier: 120 V, 50/60 Hz Heated Surface: 120 V, 0.5 A, 50/60 Hz, 65 W

### Notes

Measure your actual product for rough-in details. Install this product according to the installation instructions.

The hot water supply should be 70% of the capacity of the bath or greater. Installations will vary.

Kit is required for under-mount installations (sold separately).

Control amplifier fits 16" (406 mm) center studs. 25' (7.6 m) cables are included.