

Features

- VibrAcoustic calms and soothes with sound vibration technology.
- Six concealed speakers send sound waves through the water to gently massage the body.
- Four original instrumental compositions offer different levels of relaxation.
- Syncs with devices enabled with BLUETOOTH® wireless technology including smartphones, MP3 players, tablets, and laptops located up to 33 feet away.*
- Customize your experience with the high-resolution color touch screen.
- Fully adjustable volume above and below the water.
- Functions as a hydrotherapy bath when full of water and a stereo system when empty.
- 122 airjets release thousands of bubbles that surround, support, and massage the body.
- Variable-speed blower lets you adjust massage intensity to 18 levels.
- Zones of Control feature allows you to target massage to back, midsection, or feet.
- Molded lumbar support offers extra comfort while bathing.
- Clearflo slotted overflow for deep soaking.
- Includes 25 feet of wiring and amplifier.
- Immediate and manual purge cycles remove residual water from air channels after use.
- Requires K-7271 or K-7272 Clearflo slotted overflow bath drain (sold separately).
- Center drain.

Material

- Acrylic

Hydrotherapy

- VibrAcoustic
- BubbleMassage

Installation

- Drop-in or under-mount.

Additional Hydrotherapy Options

- Soaking Bath - K-1834-0
- Soaking Bath + Bask heated surface - K-1834-W1
- BubbleMassage air bath - K-1835-G
- BubbleMassage air bath + chromatherapy - K-1835-GCR
- VibrAcoustic + BubbleMassage air bath - K-1835-GVB
- VibrAcoustic + BubbleMassage air bath + Bask heated surface + chromatherapy - K-1835-GVBCW
- BubbleMassage air bath + Bask heated surface - K-1835-GW
- Whirlpool + heater - K-1835-H2



Codes/Standards









ASME A112.19.7/CSA B45.10
CSA B45.5/IAPMO Z124
ASTM E162
ASTM E662
UL 1795

**KOHLER® Plastic Baths and Receptors
Lifetime Limited Warranty
KOHLER® Hydrotherapy Components
Five-Year Limited Warranty**

See website for detailed warranty information.

Available Colors/Finishes

Color tiles intended for reference only.

Color	Code	Description
	0	White
	96	Biscuit
	47	Almond
	NY	Dune
	95	Ice™ Grey
	G9	Sandbar
	K4	Cashmere
	58	Thunder™ Grey
	7	Black Black™

No change in measurements if connected with required drain illustrated. (K-7272)

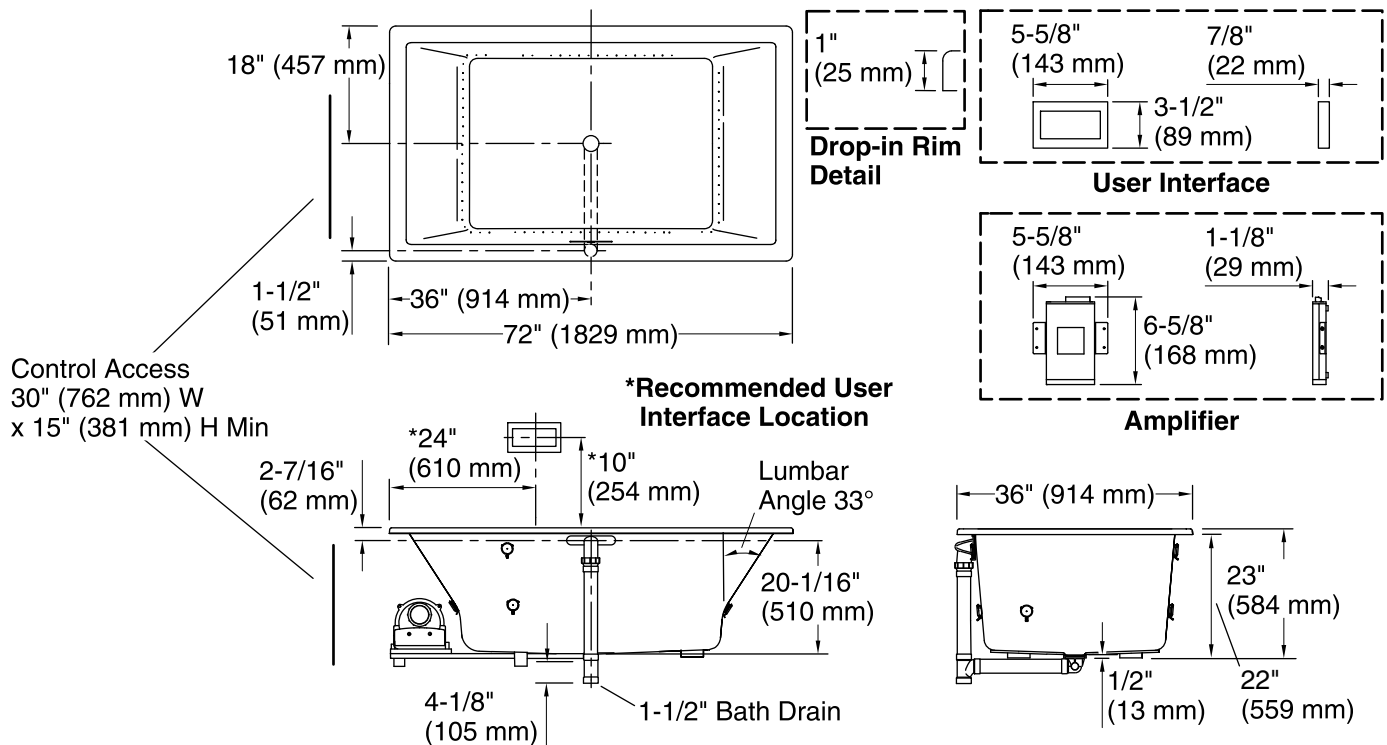

Required Electrical Service

One dedicated circuit required, protected with Class A Ground-Fault Circuit-Interrupter (GFCI). Outside North America, this device may be known as a Residual Current Device (RCD).

Blower, Amplifier: 120 V, 15 A, 60 Hz

Technical Information

All product dimensions are nominal.

Installation:	Drop-in, Under-mount
Drain location:	Center
Basin area, bottom:	45-3/4" x 25-15/16" (1162 mm x 659 mm)
Basin area, top:	65-3/8" x 29-5/16" (1661 mm x 745 mm)
Weight:	117 lbs (53.1 kg)
Minimum floor load:	58.6 lbs/ft ² (286.1 kg/m ²)
Water depth:	19-7/16" (494 mm)
Water capacity:	112.9 gal (427.4 L)
Cutout:	Drop-in, 71-1/2" x 35-1/2" (1816 mm x 902 mm)
Electrical component rating:	Blower: 120 V, 10 A, 60 Hz Amplifier: 120 V, 1.2 A, 50/60 Hz
Blower speed:	Variable
Minimum flat for door:	2-3/4" (69 mm)

Notes

Measure your actual product for rough-in details. Install this product according to the installation instructions.

The hot water supply should be 70% of the capacity of the bath or greater. Installations will vary.

Control amplifier fits 16" (406 mm) center studs. 25' (7.6 m) cables are included.

Remote blower installation kit K-1446 is available for relocating the blower. Provide access for servicing the blower.

Kit is required for under-mount installations (sold separately).

Do not relocate or alter the PVC tee or coiled flexible tubing connected to the blower. Follow the blower relocation instructions exactly.