

Features

- 8 hydromassage jets can be individually adjusted for water flow and direction.
- Variable-speed pump for adjusting massage intensity.
- Built-in heater.
- Electronic keypad.
- Generous 6-foot length provides spacious bathing for up to two people.
- Multiple pump location options give you more choices for installation and access. (See specification sheet for pump locations.)
- Coordinates with other products in the Memoirs collection.

Material

- Acrylic

Hydrotherapy

- Whirlpool

Installation

- Drop-in

Required Products/Accessories

K-9698 Flexjet® Whirlpool Trim Kit

Recommended Products/Accessories

K-1491 Bath/Whirlpool Pillow
K-1601 Bath/Whirlpool Footstop
K-1703 Whirlpool Remote Control
K-7161-AF Bath Drain
K-24916 Wireless Music Kit



Codes/Standards

ASME A112.19.7/CSA B45.10
CSA B45.5/IAPMO Z124
ASTM E162
ASTM E662
UL 1795
CSA C22.2 No. 218.2





**KOHLER® Plastic Baths and Receptors
Lifetime Limited Warranty
KOHLER® Hydrotherapy Components
Five-Year Limited Warranty**

See website for detailed warranty information.

Available Colors/Finishes

Color tiles intended for reference only.

Color	Code	Description
-------	------	-------------

	0	White
	96	Biscuit
	47	Almond
	NY	Dune
	G9	Sandbar

No change in measurements if connected with drain illustrated. (K-7161-AF)

 Recommended Faucet Location

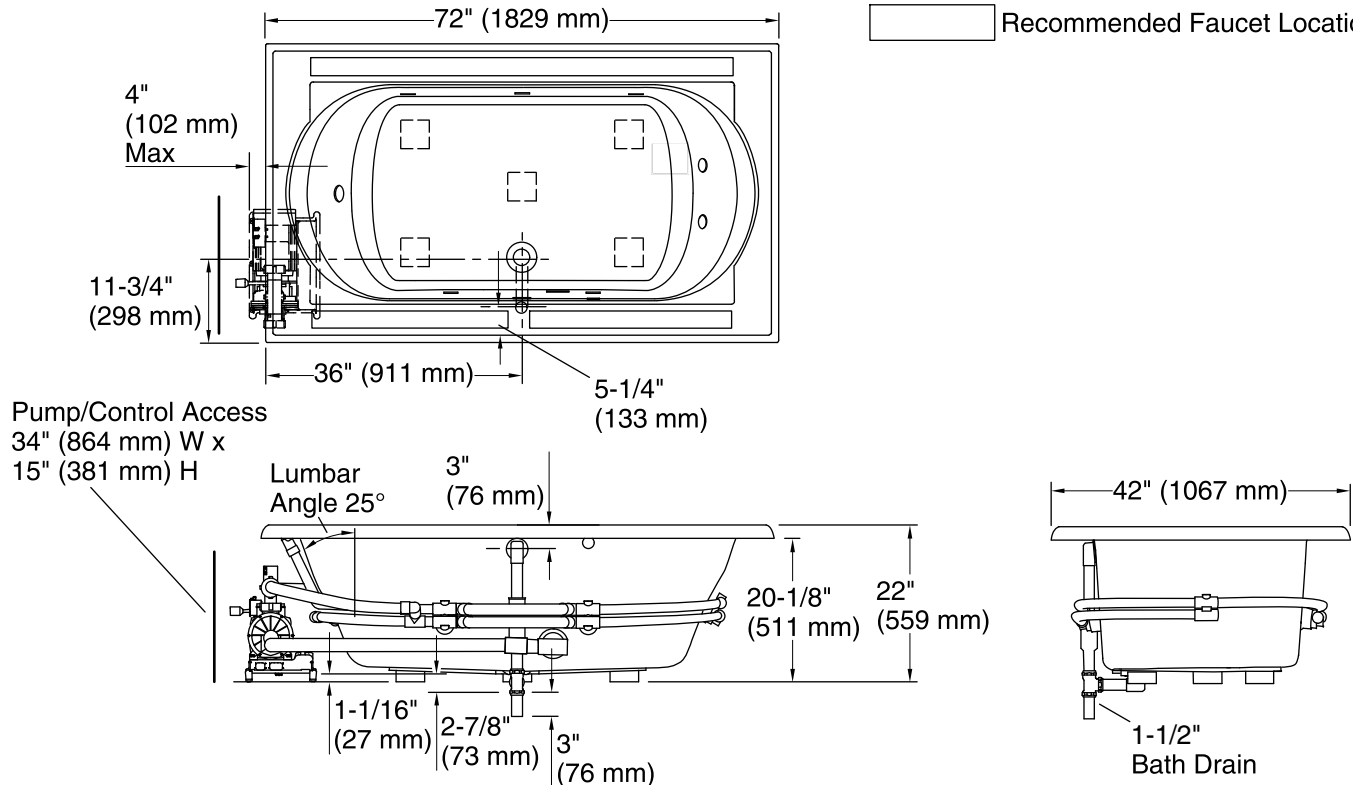

Required Electrical Service

One dedicated circuit required, protected with Class A Ground-Fault Circuit-Interrupter (GFCI). Outside North America, this device may be known as a Residual Current Device (RCD).

Pump, Heater: 240 V, 20 A, 50/60 Hz

Technical Information

All product dimensions are nominal.

Installation:	Drop-in
Drain location:	Center
Basin area, bottom:	48" x 27" (1219 mm x 686 mm)
Basin area, top:	60" x 30" (1524 mm x 762 mm)
Weight:	140 lbs (63.5 kg)
Minimum floor load:	45 lbs/ft ² (219.7 kg/m ²)
Water depth:	16" (406 mm)
Water capacity:	94 gal (355.8 L)
Cutout:	Drop-in, 70-1/2" x 40-1/2" (1791 mm x 1029 mm)
Electrical component rating:	Pump: 240 V, 11 A, 50/60 Hz Heater: 240 V, 6.3 A, 50/60 Hz, 1500 W
Pump speed:	Variable

Notes

Measure your actual product for rough-in details. Install this product according to the installation instructions.

The hot water supply should be 70% of the capacity of the bath or greater. Installations will vary.

Pump must be relocated to custom position at the time of installation. Provide adequate clearance.

This whirlpool is designed for drop-in installation only. It is not suited for use in a three wall alcove with an overhead shower.

If installing a rim-mount faucet, make sure there is no interference above or below the deck before drilling any holes.