

Features

- Bask® heated surface creates spa-like relaxation with soothing warmth on your back and neck.
- Three heat settings allow you to customize the surface temperature.
- 122 airjets release thousands of bubbles that surround, support, and massage the body.
- Variable-speed blower lets you adjust massage intensity to 18 levels.
- Zones of Control feature allows you to target massage to back, midsection, or feet.
- Lighted keypad.
- Generous 6-foot length provides an incredibly spacious bathing area.
- Immediate and manual purge cycles remove residual water from air channels after use.
- Coordinates with other products in the Memoirs collection.

Material

- Acrylic

Hydrotherapy

- BubbleMassage

Installation

- Drop-in

Additional Hydrotherapy Options

- Soaking Bath - 1417-0
- Soaking Bath + Bask heated surface - 1417-W1
- BubbleMassage air bath - 1418-G
- BubbleMassage air bath + Bask heated surface - 1418-GW
- VibrAcoustic - 1418-VB
- VibrAcoustic + Bask heated surface - 1418-VBW
- Whirlpool - 1418-H2
- Effervescence Relax Package - 1418-CT
- Effervescence Spa Package - 1418-AH
- Whirlpool Massage Package - 1418-M
- Spa Package + Massage Package - 1418-V

Recommended Products/Accessories

K-1491 Bath/Whirlpool Pillow
K-1601 Bath/Whirlpool Footstop
K-1705 Whirlpool/BubbleMassage™ Remote Control
K-7161-AF Bath Drain
K-9498 3" Keypad Trim
K-24916 Wireless Music Kit



Codes/Standards

ASME A112.19.7/CSA B45.10
CSA B45.5/IAPMO Z124
ASTM E162
ASTM E662
UL 1795
CSA C22.2 No. 218.2





**KOHLER® Plastic Baths and Receptors
Lifetime Limited Warranty
KOHLER® Hydrotherapy Components
Five-Year Limited Warranty**

See website for detailed warranty information.

Available Colors/Finishes

Color tiles intended for reference only.

Color	Code	Description
-------	------	-------------

	0	White
	96	Biscuit
	47	Almond
	NY	Dune
	G9	Sandbar

No change in measurements if connected with drain illustrated. (K-7161-AF)

 Recommended Faucet Location

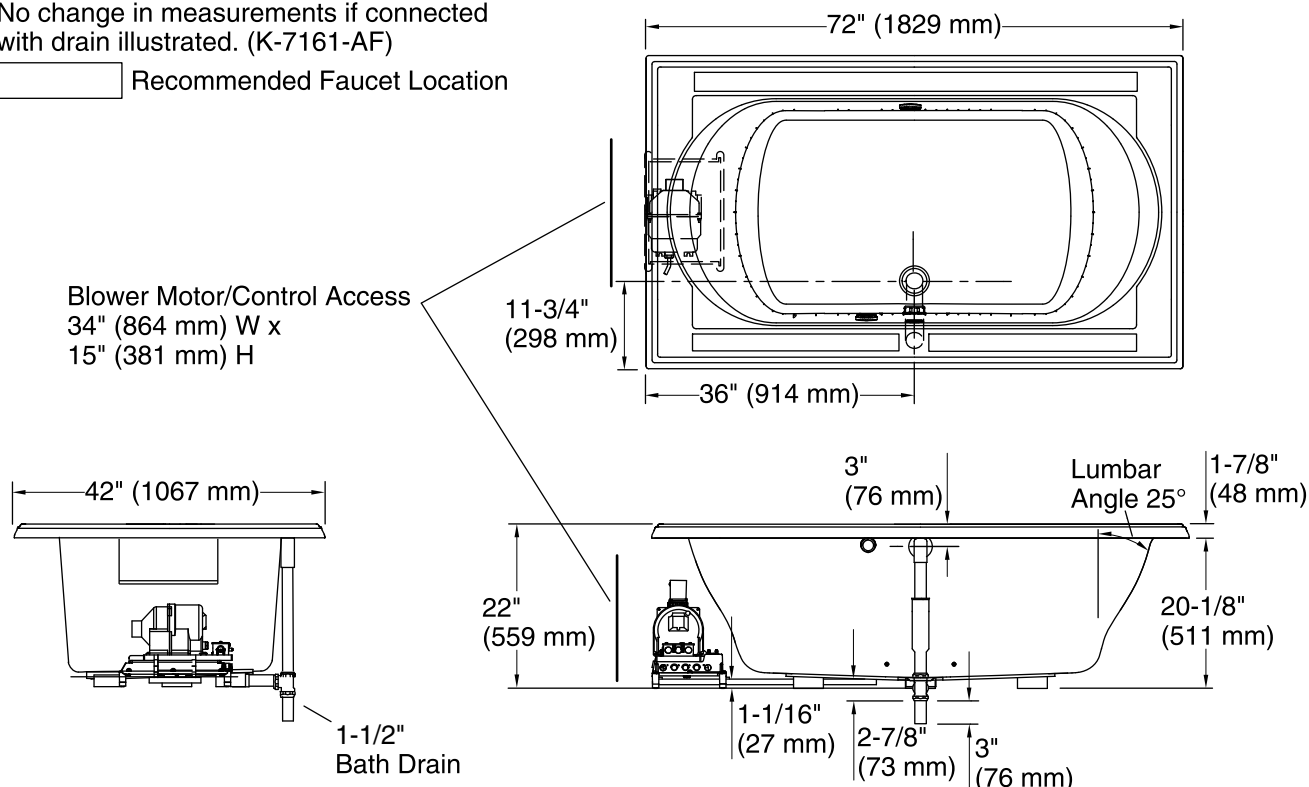

Required Electrical Service

One dedicated circuit required, protected with Class A Ground-Fault Circuit-Interrupter (GFCI). Outside North America, this device may be known as a Residual Current Device (RCD).

Blower, Heated 240 V, 15 A, 50/60 Hz
Surface:

Technical Information

All product dimensions are nominal.

Installation: Drop-in
Drain location: Center
Basin area, bottom: 48" x 27" (1219 mm x 686 mm)
Basin area, top: 60" x 30" (1524 mm x 762 mm)
Weight: 156 lbs (70.8 kg)
Minimum floor load: 54 lbs/ft² (263.7 kg/m²)
Water depth: 16" (406 mm)
Water capacity: 94 gal (355.8 L)
Cutout: Drop-in, 70-1/2" x 40-1/2" (1791 mm x 1029 mm)
Electrical component rating: Blower: 240 V, 5 A, 50/60 Hz
Heated Surface: 240 V, 0.5 A, 50/60 Hz, 65 W

Notes

Measure your actual product for rough-in details. Install this product according to the installation instructions.

The hot water supply should be 70% of the capacity of the bath or greater. Installations will vary.

If relocating the blower motor, do not relocate or alter the PVC tee or coiled flexible tubing connected to the blower. Follow the blower relocation instructions exactly. Provide access for servicing the blower.

If installing a rim-mount faucet, make sure there is no interference above or below the deck before drilling any holes.