

### Features

- VibrAcoustic calms and soothes with sound vibration technology.
- Six concealed speakers send sound waves through the water to gently massage the body.
- Four original instrumental compositions offer different levels of relaxation.
- Syncs with devices enabled with BLUETOOTH® wireless technology including smartphones, MP3 players, tablets, and laptops located up to 33 feet away.\*
- Customize your experience with the high-resolution color touch screen.
- Fully adjustable volume above and below the water.
- Functions as a hydrotherapy bath when full of water and a stereo system when empty.
- Bask® heated surface creates spa-like relaxation with soothing warmth on your back and neck.
- Three heat settings allow you to customize the surface temperature.
- Molded lumbar support and armrests offer extra comfort while bathing.
- Integral apron.
- Integral flange helps prevent water from seeping behind wall and simplifies alcove installation.
- Textured bottom surface.
- Left-hand drain.
- Includes 25 feet of wiring and amplifier.

### Material

- Acrylic

### Hydrotherapy

- VibrAcoustic

### Installation

- Three-wall alcove.
- Requires 110V electrical service.

### Additional Hydrotherapy Options

- Soaking Bath - K-1184-LA
- Soaking Bath + Bask heated surface - K-1184-LAW
- BubbleMassage air bath - K-1357-GLA
- BubbleMassage air bath + Bask heated surface - K-1357-GLAW
- VibrAcoustic - K-1357-VBLA
- VibrAcoustic + Bask heated surface - K-1357-VBLAW
- Whirlpool - K-1357-LA
- Whirlpool + Bask heated surface - K-1357-LAW
- Whirlpool + heater - K-1357-HL

### Recommended Products/Accessories

1184460 Under-Mount Installation Kit



### Codes/Standards

CSA B45.5/IAPMO Z124  
ASTM E162  
ASTM E662  
UL 1795  
CSA C22.2 No. 218.2

### KOHLER® Plastic Baths and Receptors Lifetime Limited Warranty





See website for detailed warranty information.

The BLUETOOTH® word mark and logos are registered trademarks owned by Bluetooth SIG, Inc. and any use of such marks by Kohler Co. is under license. Other trademarks and trade names are those of their respective owners.

### Available Colors/Finishes

*Color tiles intended for reference only.*

#### Color Code Description

	0	White
	96	Biscuit
	47	Almond
	NY	Dune
	G9	Sandbar

No change in measurements if connected with drain illustrated. (K-7161-AF)

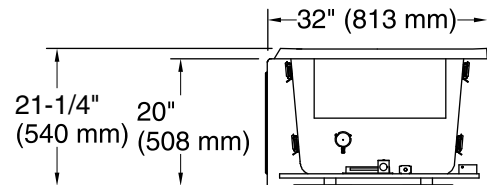
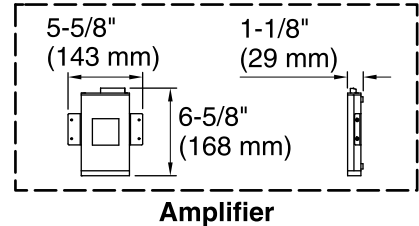
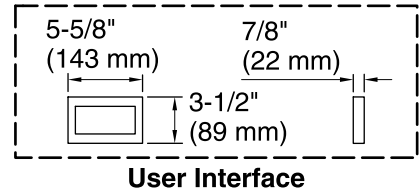
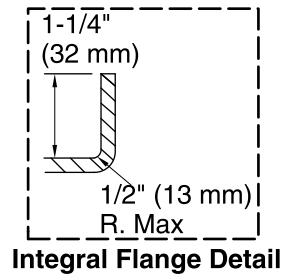
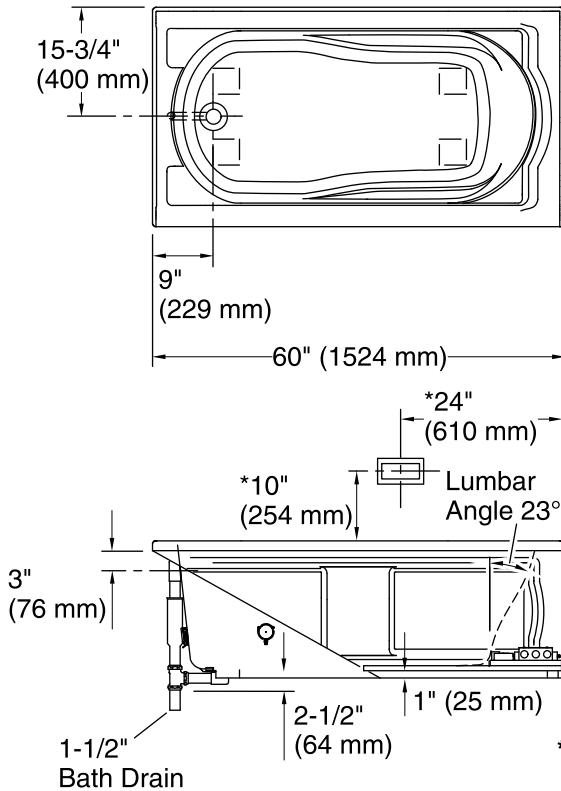

**\*Recommended User Interface Location**

### Required Electrical Service

One circuit required, protected with Class A Ground-Fault Circuit-Interrupter (GFCI). Outside North America, this device may be known as a Residual Current Device (RCD).

Amplifier, Heated Surface: 120 V, 15 A, 50/60 Hz

### Technical Information

All product dimensions are nominal.

Installation:	Three-wall alcove
Drain location:	Left
Basin area, bottom:	42" x 20" (1067 mm x 508 mm)
Basin area, top:	51" x 24" (1295 mm x 610 mm)
Weight:	91 lbs (41.3 kg)
Minimum floor load:	47 lbs/ft <sup>2</sup> (229.5 kg/m <sup>2</sup> )
Water depth:	14" (356 mm)
Water capacity:	60 gal (227.1 L)
Electrical component rating:	Amplifier: 120 V, 1.1 A, 50/60 Hz Heated Surface: 120 V, 0.5 A, 50/60 Hz, 65 W
Amplifier channels:	2 at 15 W per channel 2 at 30 W per channel

### Notes

Measure your actual product for rough-in details. Install this product according to the installation instructions.

The hot water supply should be 70% of the capacity of the bath or greater. Installations will vary.

Control amplifier fits 16" (406 mm) center studs. 25' (7.6 m) cables are included.